

Version 1.0

Published May 2013

Copyright©2013 ASRock INC. All rights reserved.



## Copyright Notice:

No part of this documentation may be reproduced, transcribed, transmitted, or translated in any language, in any form or by any means, except duplication of documentation by the purchaser for backup purpose, without written consent of ASRock Inc.

Products and corporate names appearing in this documentation may or may not be registered trademarks or copyrights of their respective companies, and are used only for identification or explanation and to the owners' benefit, without intent to infringe.

## Disclaimer:

Specifications and information contained in this documentation are furnished for informational use only and subject to change without notice, and should not be constructed as a commitment by ASRock. ASRock assumes no responsibility for any errors or omissions that may appear in this documentation.

With respect to the contents of this documentation, ASRock does not provide warranty of any kind, either expressed or implied, including but not limited to the implied warranties or conditions of merchantability or fitness for a particular purpose.

In no event shall ASRock, its directors, officers, employees, or agents be liable for any indirect, special, incidental, or consequential damages (including damages for loss of profits, loss of business, loss of data, interruption of business and the like), even if ASRock has been advised of the possibility of such damages arising from any defect or error in the documentation or product.



This device complies with Part 15 of the FCC Rules. Operation is subject to the following two conditions:

- (1) this device may not cause harmful interference, and
- (2) this device must accept any interference received, including interference that may cause undesired operation.

## CALIFORNIA, USA ONLY

The Lithium battery adopted on this motherboard contains Perchlorate, a toxic substance controlled in Perchlorate Best Management Practices (BMP) regulations passed by the California Legislature. When you discard the Lithium battery in California, USA, please follow the related regulations in advance.

“Perchlorate Material-special handling may apply, see [www.dtsc.ca.gov/hazardouswaste/perchlorate](http://www.dtsc.ca.gov/hazardouswaste/perchlorate)”

**ASRock Website: <http://www.asrock.com>**

## AUSTRALIA ONLY

Our goods come with guarantees that cannot be excluded under the Australian Consumer Law. You are entitled to a replacement or refund for a major failure and compensation for any other reasonably foreseeable loss or damage caused by our goods. You are also entitled to have the goods repaired or replaced if the goods fail to be of acceptable quality and the failure does not amount to a major failure. If you require assistance please call ASRock Tel : +886-2-28965588 ext.123 (Standard International call charges apply)

The terms HDMI™ and HDMI High-Definition Multimedia Interface, and the HDMI logo are trademarks or registered trademarks of HDMI Licensing LLC in the United States and other countries.



# Motherboard Layout

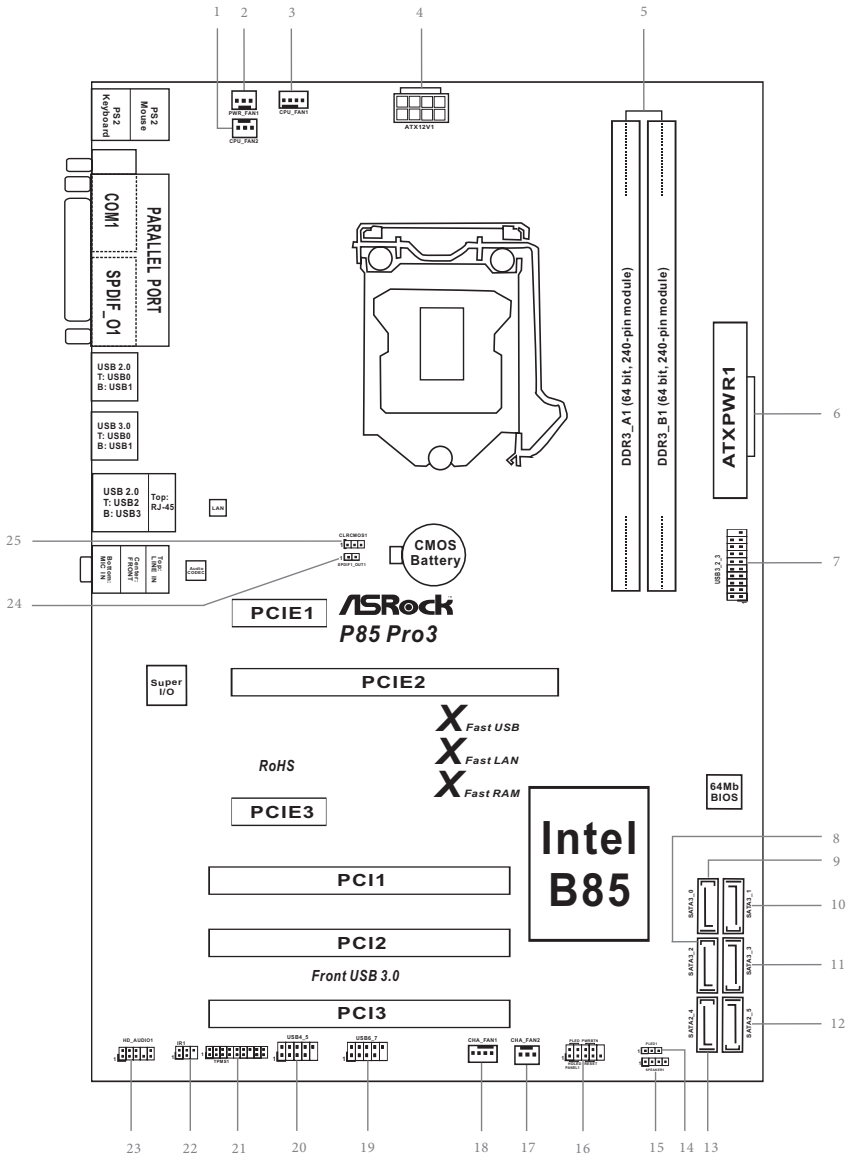

No.	Description
1	CPU Fan Connector (CPU_FAN2)
2	Power Fan Connector (PWR_FAN1)
3	CPU Fan Connector (CPU_FAN1)
4	ATX 12V Power Connector (ATX12V1)
5	2 x 240-pin DDR3 DIMM Slots (DDR3_A1, DDR3_B1)
6	ATX Power Connector (ATXPWR1)
7	USB 3.0 Header (USB3_2_3)
8	SATA3 Connector (SATA3_2)
9	SATA3 Connector (SATA3_0)
10	SATA3 Connector (SATA3_1)
11	SATA3 Connector (SATA3_3)
12	SATA2 Connector (SATA2_5)
13	SATA2 Connector (SATA2_4)
14	Power LED Header (PLED1)
15	Chassis Speaker Header (SPEAKER1)
16	System Panel Header (PANEL1)
17	Chassis Fan Connector (CHA_FAN2)
18	Chassis Fan Connector (CHA_FAN1)
19	USB 2.0 Header (USB6_7)
20	USB 2.0 Header (USB4_5)
21	TPM Header (TPMS1)
22	Infrared Module Header (IR1)
23	Front Panel Audio Header (HD_AUDIO1)
24	SPDIF Out Connector (SPDIF_OUT)
25	Clear CMOS Jumper (CLRCMOS1)

## I/O Panel

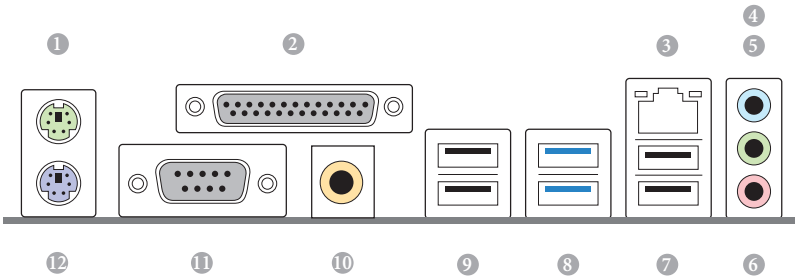

No.	Description	No.	Description
1	PS/2 Mouse Port	7	USB 2.0 Ports (USB_23)
2	Parallel Port	8	USB 3.0 Ports (USB3_01)
3	LAN RJ-45 Port*	9	USB 2.0 Ports (USB_01)
4	Line In (Light Blue)	10	Coaxial SPDIF Out Port
5	Front Speaker (Lime)	11	COM Port
6	Microphone (Pink)	12	PS/2 Keyboard Port

\* There are two LEDs on each LAN port. Please refer to the table below for the LAN port LED indications.

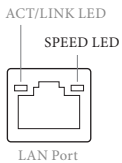

Activity / Link LED		Speed LED	
Status	Description	Status	Description
Off	No Link	Off	10Mbps connection
Blinking	Data Activity	Orange	100Mbps connection
On	Link	Green	1Gbps connection

# Chapter 1 Introduction

Thank you for purchasing ASRock P85 Pro3 motherboard, a reliable motherboard produced under ASRock's consistently stringent quality control. It delivers excellent performance with robust design conforming to ASRock's commitment to quality and endurance.



*Because the motherboard specifications and the BIOS software might be updated, the content of this documentation will be subject to change without notice. In case any modifications of this documentation occur, the updated version will be available on ASRock's website without further notice. If you require technical support related to this motherboard, please visit our website for specific information about the model you are using. You may find the latest VGA cards and CPU support list on ASRock's website as well. ASRock website <http://www.asrock.com>.*

## 1.1 Package Contents

- ASRock P85 Pro3 Motherboard (ATX Form Factor)
- ASRock P85 Pro3 Quick Installation Guide
- ASRock P85 Pro3 Support CD
- 2 x Serial ATA (SATA) Data Cables (Optional)
- 1 x I/O Panel Shield

## 1.2 Specifications

- Platform**
- ATX Form Factor
  - All Solid Capacitor design

- CPU**
- Supports 4<sup>th</sup> Generation Intel® Core™ i7 / i5 / i3 / Xeon® / Pentium® / Celeron® in LGA1150 Package
  - Digi Power Design
  - 4 Power Phase Design
  - Supports Intel® Turbo Boost 2.0 Technology

- Chipset**
- Intel® B85
  - Supports Intel® Small Business Advantage 2.0

- Memory**
- Dual Channel DDR3 Memory Technology
  - 2 x DDR3 DIMM slots
  - Supports DDR3 1600/1333/1066 non-ECC, un-buffered memory
  - Max. capacity of system memory: 16GB (see CAUTION)
  - Supports Intel® Extreme Memory Profile (XMP)1.3/1.2

- Expansion Slot**
- 1 x PCI Express 3.0 x16 slot
  - 2 x PCI Express 2.0 x1 slots
  - 3 x PCI slots

- Audio**
- 5.1 CH HD Audio (Realtek ALC662 Audio Codec)
  - TI® NE5532 Premium Headset Amplifier (supports up to 600 Ohms headsets)

- LAN**
- PCIE x1 Gigabit LAN 10/100/1000 Mb/s
  - Realtek RTL8111G
  - Supports Wake-On-LAN
  - Supports LAN Cable Detection
  - Supports Energy Efficient Ethernet 802.3az
  - Supports PXE

**Rear Panel I/O**

- 1 x PS/2 Mouse Port
- 1 x PS/2 Keyboard Port
- 1 x Serial Port: COM1
- 1 x Parallel Port (ECP/EPP support)
- 1 x Coaxial SPDIF Out Port
- 4 x USB 2.0 Ports
- 2 x USB 3.0 Ports
- 1 x RJ-45 LAN Port with LED (ACT/LINK LED and SPEED LED)
- HD Audio Jack: Line in / Front Speaker / Microphone

**Storage**

- 4 x SATA3 6.0 Gb/s connectors, support NCQ, AHCI and Hot Plug
- 2 x SATA2 3.0 Gb/s connectors, support NCQ, AHCI and Hot Plug

**Connector**

- 1 x IR header
- 1 x Power LED header
- 1 x TPM header
- 2 x CPU Fan connectors (1 x 4-pin, 1 x 3-pin)
- 2 x Chassis Fan connectors (1 x 4-pin, 1 x 3-pin)
- 1 x Power Fan connector (3-pin)
- 1 x 24 pin ATX power connector
- 1 x 8 pin 12V power connector
- 1 x Front panel audio connector
- 1 x SPDIF Out connector
- 2 x USB 2.0 headers (support 4 USB 2.0 ports)
- 1 x USB 3.0 header (supports 2 USB 3.0 ports)

**BIOS Feature**

- 64Mb AMI UEFI Legal BIOS with Multilingual GUI support
- ACPI 1.1 Compliance Wake Up Events
- SMBIOS 2.3.1 Support
- CPU, DRAM, PCH 1.05V Voltage Multi-adjustment

**Support CD**

- Drivers, Utilities, AntiVirus Software (Trial Version), Cyber-Link MediaEspresso 6.5 Trial, Google Chrome Browser and Toolbar, Start8



**Hardware  
Monitor**

- CPU/Chassis/Power Temperature Sensing
- CPU/Chassis/Power Fan Tachometer
- CPU/Chassis Quiet Fan (Allow Chassis Fan Speed Auto-Adjust by CPU Temperature)
- CPU/Chassis Fan Multi-Speed Control
- Voltage Monitoring: +12V, +5V, +3.3V, CPU Vcore

**OS**

- Microsoft® Windows® 8 / 8 64-bit / 7 / 7 64-bit compliant

**Certifica-  
tions**

- FCC, CE, WHQL
- ErP/EuP Ready (ErP/EuP ready power supply is required)

\* For detailed product information, please visit our website: <http://www.asrock.com>



*Please realize that there is a certain risk involved with overclocking, including adjusting the setting in the BIOS, applying Untied Overclocking Technology, or using third-party overclocking tools. Overclocking may affect your system's stability, or even cause damage to the components and devices of your system. It should be done at your own risk and expense. We are not responsible for possible damage caused by overclocking.*



*Due to limitation, the actual memory size may be less than 4GB for the reservation for system usage under Windows® 32-bit operating systems. Windows® 64-bit operating systems do not have such limitations. You can use ASRock XFast RAM to utilize the memory that Windows® cannot use.*

## 1.3 Unique Features



### ASRock A-Tuning

A-Tuning is ASRock's multi purpose software suite with a new interface, more new features and improved utilities, including XFast RAM, Dehumidifier, Good Night LED, FAN-Tastic Tuning, OC Tweaker and a whole lot more.



### ASRock Instant Flash

ASRock Instant Flash is a BIOS flash utility embedded in Flash ROM. This convenient BIOS update tool allows you to update the system BIOS in a few clicks without preparing an additional floppy diskette or other complicated flash utility. Just save the new BIOS file to your USB storage and launch this tool by pressing <F6> or <F2> during POST to enter the BIOS setup menu to access ASRock Instant Flash. Please be noted that the USB flash drive or hard drive must use FAT32/16/12 file system.



### ASRock APP Charger

Simply by installing the ASRock APP Charger makes your iPhone/iPad/iPod Touch charge up to 40% faster than before on your computer. ASRock APP Charger allows you to quickly charge many Apple devices simultaneously and even supports continuous charging when your PC enters into Standby mode (S1), Suspend to RAM (S3), hibernation mode (S4) or power off (S5).



### ASRock XFast USB

ASRock XFast USB can boost the performance of your USB storage devices. The performance may depend on the properties of the device.



### ASRock XFast LAN

ASRock XFast LAN provides faster internet access, which includes the benefits listed below. LAN Application Prioritization: You can configure your application's priority ideally and add new programs to the list. Lower Latency in Game: After setting online game's priority higher, it can lower the latency in games. Traffic Shaping: You can watch Youtube HD videos and download simultaneously. Real-Time Analysis of Your Data: With the status window, you can easily recognize which data streams you are currently transferring.



### ASRock XFast RAM

ASRock XFast RAM is included in A-Tuning. It fully utilizes the memory space that cannot be used under Windows® 32-bit operating systems. ASRock XFast RAM shortens the loading time of previously visited websites, making web surfing faster than ever. And it also boosts the speed of Adobe Photoshop 5 times faster. Another advantage of ASRock XFast RAM is that it reduces the frequency of accessing your SSDs or HDDs in order to extend their lifespan.



### ASRock Crashless BIOS

ASRock Crashless BIOS allows users to update their BIOS without fear of failing. If power loss occurs during the BIOS updating process, ASRock Crashless BIOS will automatically finish the BIOS update procedure after regaining power. Please note that BIOS files need to be placed in the root directory of your USB disk. Only USB 2.0 ports support this feature.



### ASRock OMG (Online Management Guard)

Administrators are able to establish an internet curfew or restrict internet access at specified times via OMG. You may schedule the starting and ending hours of internet access granted to other users. In order to prevent users from bypassing OMG, guest accounts without permission to modify the system time are required.



### ASRock Internet Flash

ASRock Internet Flash downloads and updates the latest UEFI firmware version from our servers for you without entering Windows® OS. Please setup network configuration before using Internet Flash.



### ASRock System Browser

ASRock System Browser shows the overview of your current PC and the devices connected.



### ASRock Dehumidifier Function

Users may prevent motherboard damages due to dampness by enabling “Dehumidifier Function”. When enabling Dehumidifier Function, the computer will power on automatically to dehumidify the system after entering S4/S5 state.



### ASRock Easy Driver Installer

For users that don't have an optical disk drive to install the drivers from our support CD, Easy Driver Installer is a handy tool in the UEFI that installs the LAN driver to your system via an USB storage device, then downloads and installs the other required drivers automatically.

## ASRock Interactive UEFI

ASRock Interactive UEFI is a blend of system configuration tools, cool sound effects and stunning visuals. The unprecedented UEFI provides a more attractive interface and more amusement.

## ASRock Fast Boot

With ASRock's exclusive Fast Boot technology, it takes less than 1.5 seconds to logon to Windows 8 from a cold boot. No more waiting! The speedy boot will completely change your user experience and behavior.

## ASRock Restart to UEFI

Windows® 8 brings the ultimate boot up experience. The lightning boot up speed makes it hard to access the UEFI setup. ASRock Restart to UEFI allows users to enter the UEFI automatically when turning on the PC. By enabling this function, the PC will enter the UEFI directly after you restart.

## ASRock USB Key

In a world where time is money, why waste precious time everyday typing usernames to log in to Windows? Why should we even bother memorizing those foot long passwords? Just plug in the USB Key and let your computer log in to windows automatically!

## ASRock FAN-Tastic Tuning

ASRock FAN-Tastic Tuning is included in A-Tuning. Configure up to five different fan speeds using the graph. The fans will automatically shift to the next speed level when the assigned temperature is met.

## ASRock Good Night LED

ASRock Good Night LED technology offers you a better sleeping environment by extinguishing the unessential LEDs. By enabling Good Night LED in the BIOS, the Power/HDD/LAN LEDs will be switched off when the system is powered on. Good Night LED will automatically switch off the Power and Keyboard LEDs when the system enters into Standby/Hibernation mode as well.

## Chapter 2 Installation

This is an ATX form factor motherboard. Before you install the motherboard, study the configuration of your chassis to ensure that the motherboard fits into it.

### Pre-installation Precautions

Take note of the following precautions before you install motherboard components or change any motherboard settings.

- Make sure to unplug the power cord before installing or removing the motherboard. Failure to do so may cause physical injuries to you and damages to motherboard components.
- In order to avoid damage from static electricity to the motherboard's components, NEVER place your motherboard directly on a carpet. Also remember to use a grounded wrist strap or touch a safety grounded object before you handle the components.
- Hold components by the edges and do not touch the ICs.
- Whenever you uninstall any components, place them on a grounded anti-static pad or in the bag that comes with the components.
- When placing screws to secure the motherboard to the chassis, please do not overtighten the screws! Doing so may damage the motherboard.

## 2.1 Installing the CPU



1. Before you insert the 1150-Pin CPU into the socket, please check if the **PnP cap** is on the socket, if the CPU surface is unclean, or if there are any **bent pins** in the socket. Do not force to insert the CPU into the socket if above situation is found. Otherwise, the CPU will be seriously damaged.
2. Unplug all power cables before installing the CPU.

1

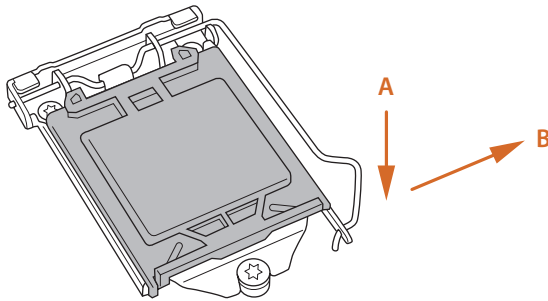

2

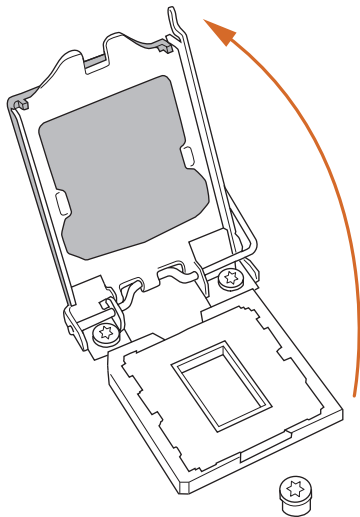

3

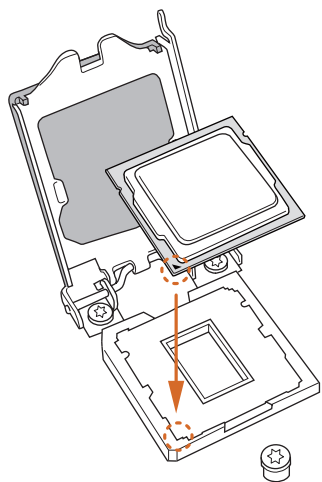

4

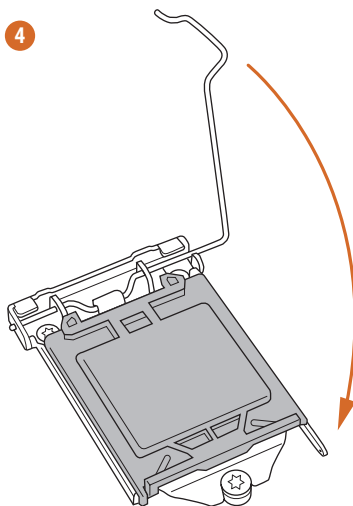

5

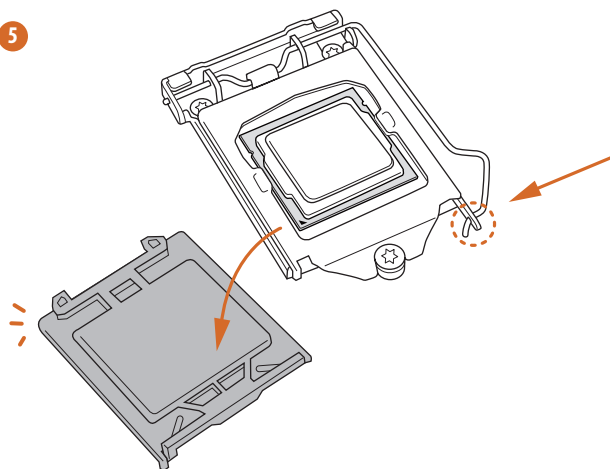



*Please save and replace the cover if the processor is removed. The cover must be placed if you wish to return the motherboard for after service.*



## 2.2 Installing the CPU Fan and Heatsink

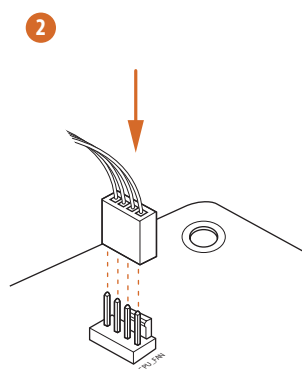
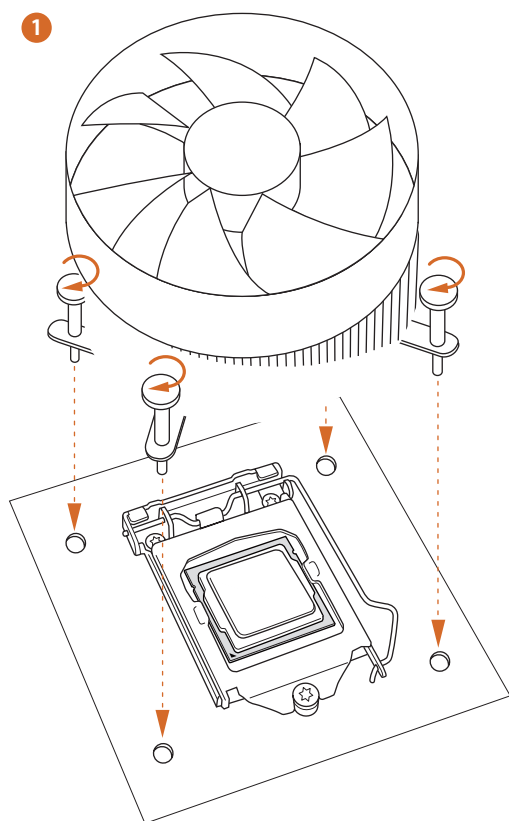
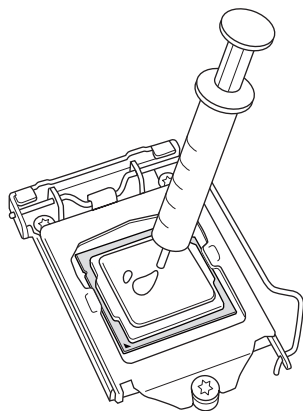

## 2.3 Installing Memory Modules (DIMM)

This motherboard provides two 240-pin DDR3 (Double Data Rate 3) DIMM slots, and supports Dual Channel Memory Technology.



1. For dual channel configuration, you always need to install identical (the same brand, speed, size and chip-type) DDR3 DIMM pairs.
2. It is unable to activate Dual Channel Memory Technology with only one memory module installed.
3. It is not allowed to install a DDR or DDR2 memory module into a DDR3 slot; otherwise, this motherboard and DIMM may be damaged.



*The DIMM only fits in one correct orientation. It will cause permanent damage to the motherboard and the DIMM if you force the DIMM into the slot at incorrect orientation.*

1

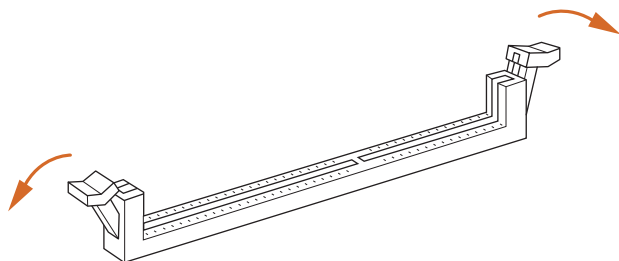

2

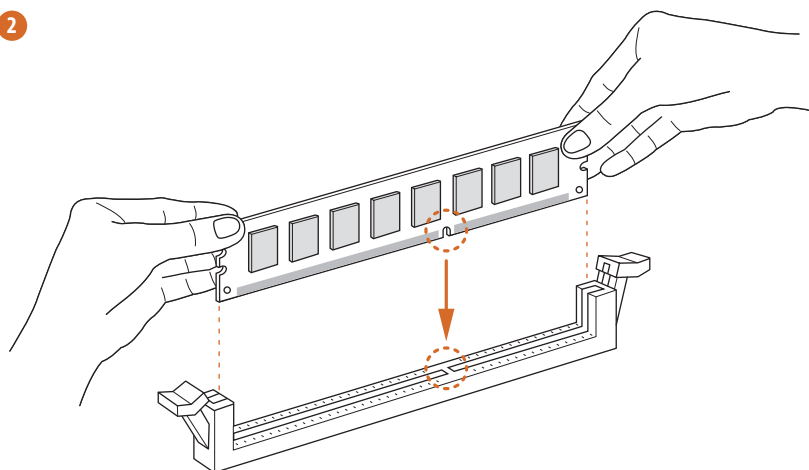

3

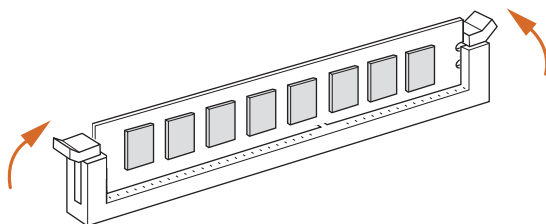

## 2.4 Expansion Slots (PCI and PCI Express Slots)

There are 3 PCI slots and 3 PCI Express slots on the motherboard.



*Before installing an expansion card, please make sure that the power supply is switched off or the power cord is unplugged. Please read the documentation of the expansion card and make necessary hardware settings for the card before you start the installation.*

### **PCI slots:**

The PCI1, PCI2 and PCI3 slots are used to install expansion cards that have 32-bit PCI interface.

### **PCIe slots:**

PCIE1 (PCIe 2.0 x1 slot) is used for PCI Express x1 lane width graphics cards.

PCIE2 (PCIe 3.0 x16 slot) is used for PCI Express x16 lane width graphics cards.

PCIE3 (PCIe 2.0 x1 slot) is used for PCI Express x1 lane width graphics cards.

## 2.5 Jumpers Setup

The illustration shows how jumpers are setup. When the jumper cap is placed on the pins, the jumper is “Short”. If no jumper cap is placed on the pins, the jumper is “Open”. The illustration shows a 3-pin jumper whose pin1 and pin2 are “Short” when a jumper cap is placed on these 2 pins.

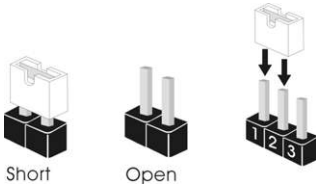

Clear CMOS Jumper  
(CLRCMOS1)  
(see p.1, No. 25)

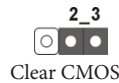

CLRCMOS1 allows you to clear the data in CMOS. To clear and reset the system parameters to default setup, please turn off the computer and unplug the power cord from the power supply. After waiting for 15 seconds, use a jumper cap to short pin2 and pin3 on CLRCMOS1 for 5 seconds. However, please do not clear the CMOS right after you update the BIOS. If you need to clear the CMOS when you just finish updating the BIOS, you must boot up the system first, and then shut it down before you do the clear-CMOS action. Please be noted that the password, date, time, and user default profile will be cleared only if the CMOS battery is removed.

## 2.6 Onboard Headers and Connectors



Onboard headers and connectors are NOT jumpers. Do NOT place jumper caps over these headers and connectors. Placing jumper caps over the headers and connectors will cause permanent damage to the motherboard.

System Panel Header  
(9-pin PANEL1)  
(see p.1, No. 16)

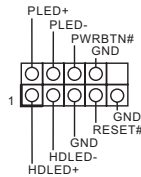

Connect the power switch, reset switch and system status indicator on the chassis to this header according to the pin assignments below. Note the positive and negative pins before connecting the cables.



**PWRBTN (Power Switch):**

Connect to the power switch on the chassis front panel. You may configure the way to turn off your system using the power switch.

**RESET (Reset Switch):**

Connect to the reset switch on the chassis front panel. Press the reset switch to restart the computer if the computer freezes and fails to perform a normal restart.

**PLED (System Power LED):**

Connect to the power status indicator on the chassis front panel. The LED is on when the system is operating. The LED keeps blinking when the system is in S1/S3 sleep state. The LED is off when the system is in S4 sleep state or powered off (S5).

**HDLED (Hard Drive Activity LED):**

Connect to the hard drive activity LED on the chassis front panel. The LED is on when the hard drive is reading or writing data.

The front panel design may differ by chassis. A front panel module mainly consists of power switch, reset switch, power LED, hard drive activity LED, speaker and etc. When connecting your chassis front panel module to this header, make sure the wire assignments and the pin assignments are matched correctly.

Power LED Header  
(3-pin PLED1)  
(see p.1, No. 14)



Please connect the chassis power LED to this header to indicate the system's power status.

Serial ATA2 Connectors

(SATA2\_4:  
see p.1, No. 13)  
(SATA2\_5:  
see p.1, No. 12)



These two SATA2 connectors support SATA data cables for internal storage devices with up to 3.0 Gb/s data transfer rate.

Serial ATA3 Connectors

(SATA3\_0:  
see p.1, No. 9)  
(SATA3\_1:  
see p.1, No. 10)  
(SATA3\_2:  
see p.1, No. 8)  
(SATA3\_3:  
see p.1, No. 11)

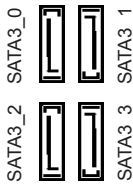

These four SATA3 connectors support SATA data cables for internal storage devices with up to 6.0 Gb/s data transfer rate.

USB 2.0 Headers

(9-pin USB4\_5)  
(see p.1, No. 20)  
(9-pin USB6\_7)  
(see p.1, No. 19)

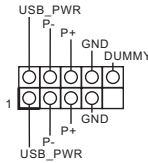

Besides four USB 2.0 ports on the I/O panel, there are two headers on this motherboard. Each USB 2.0 header can support two ports.

USB 3.0 Header

(19-pin USB3\_2\_3)  
(see p.1, No. 7)

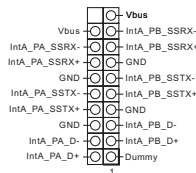

Besides two USB 3.0 ports on the I/O panel, there is one header on this motherboard. Each USB 3.0 header can support two ports.

Front Panel Audio Header

(9-pin HD\_AUDIO1)  
(see p.1, No. 23)

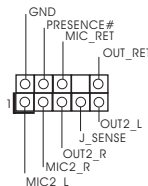

This header is for connecting audio devices to the front audio panel.



1. High Definition Audio supports Jack Sensing, but the panel wire on the chassis must support HDA to function correctly. Please follow the instructions in our manual and chassis manual to install your system.
2. If you use an AC'97 audio panel, please install it to the front panel audio header by the steps below:
  - A. Connect Mic\_IN (MIC) to MIC2\_L.
  - B. Connect Audio\_R (RIN) to OUT2\_R and Audio\_L (LIN) to OUT2\_L.
  - C. Connect Ground (GND) to Ground (GND).
  - D. MIC\_RET and OUT\_RET are for the HD audio panel only. You don't need to connect them for the AC'97 audio panel.
  - E. To activate the front mic, go to the "FrontMic" Tab in the Realtek Control panel and adjust "Recording Volume".

Chassis Speaker Header  
(4-pin SPEAKER1)  
(see p.1, No. 15)

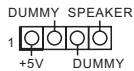

Please connect the chassis speaker to this header.

SPDIF Out Connector  
(2-pin SPDIF\_OUT1)  
(see p.1, No. 24)



Please connect the SPDIF\_OUT connector of a HDMI VGA card to this header with a cable.

Chassis and Power Fan Connectors  
(4-pin CHA\_FAN1)  
(see p.1, No. 18)

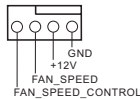

Please connect fan cables to the fan connectors and match the black wire to the ground pin.

(3-pin CHA\_FAN2)  
(see p.1, No. 17)



(3-pin PWR\_FAN1)  
(see p.1, No. 2)

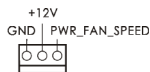



CPU Fan Connectors

(4-pin CPU\_FAN1)

(see p.1, No. 3)

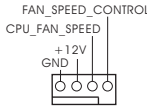

This motherboard provides a 4-Pin CPU fan (Quiet Fan) connector. If you plan to connect a 3-Pin CPU fan, please connect it to Pin 1-3.

(3-pin CPU\_FAN2)

(see p.1, No. 1)



ATX Power Connector

(24-pin ATXPWR1)

(see p.1, No. 6)

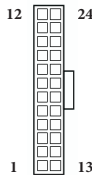

This motherboard provides a 24-pin ATX power connector. To use a 20-pin ATX power supply, please plug it along Pin 1 and Pin 13.

ATX 12V Power Connector

(8-pin ATX12V1)

(see p.1, No. 4)

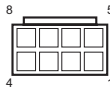

This motherboard provides an 8-pin ATX 12V power connector. To use a 4-pin ATX power supply, please plug it along Pin 1 and Pin 5.

Infrared Module Header

(5-pin IR1)

(see p.1, No. 22)

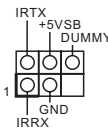

This header supports an optional wireless transmitting and receiving infrared module.

TPM Header

(17-pin TPMS1)

(see p.1, No. 21)

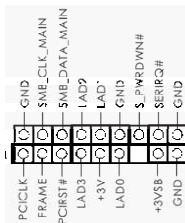

This connector supports Trusted Platform Module (TPM) system, which can securely store keys, digital certificates, passwords, and data. A TPM system also helps enhance network security, protects digital identities, and ensures platform integrity.

# 1 Einleitung

Vielen Dank, dass Sie sich für das P85 Pro3 von ASRock entschieden haben – ein zuverlässiges Motherboard, das konsequent unter der strengen Qualitätskontrolle von ASRock hergestellt wurde. Es liefert ausgezeichnete Leistung mit robustem Design, das ASRocks Streben nach Qualität und Beständigkeit erfüllt.



*Da die technischen Daten des Motherboards sowie die BIOS-Software aktualisiert werden können, kann der Inhalt dieser Dokumentation ohne Ankündigung geändert werden. Falls diese Dokumentation irgendwelchen Änderungen unterliegt, wird die aktualisierte Version ohne weitere Hinweise auf der ASRock-Webseite zur Verfügung gestellt. Sollten Sie technische Hilfe in Bezug auf dieses Motherboard benötigen, erhalten Sie auf unserer Webseite spezifischen Informationen über das von Ihnen verwendete Modell. Auch finden Sie eine aktuelle Liste unterstützter VGA-Karten und Prozessoren auf der ASRock-Webseite: ASRock-Webseite <http://www.asrock.com>.*

## 1.1 Lieferumfang

- ASRock P85 Pro3-Motherboard (ATX-Formfaktor)
- ASRock P85 Pro3-Schnellinstallationsanleitung
- ASRock P85 Pro3-Support-CD
- 2 x Serial-ATA- (SATA) Datenkabel (optional)
- 1 x E/A-Blendenabschirmung

## 1.2 Technische Daten

- Plattform**
- ATX-Formfaktor
  - Vollständig solides Kondensatordesign

- Prozessor**
- Unterstützt Intel® Core™ i7 / i5 / i3 / Xeon® / Pentium® / Celeron® der 4. Generation im LGA1150-Paket
  - Digipower-Design
  - 4-Leistungsphasendesign
  - Unterstützt Intel® Turbo Boost 2.0-Technologie

- Chipsatz**
- Intel® B85
  - Unterstützt Intel® Small Business Advantage 2.0

- Speicher**
- Dualkanal-DDR3-Speichertechnologie
  - 2 x DDR3-DIMM-Steckplätze
  - Unterstützt DDR3 1600/1333/1066 non-ECC, ungepufferter Speicher
  - Systemspeicher, max. Kapazität: 16GB (siehe ACHTUNG)
  - Unterstützt Intel® Extreme Memory Profile (XMP)1.3/1.2

- Erweiterungssteckplatz**
- 1 x PCI-Express 3,0-x16-Steckplatz
  - 2 x PCI-Express 2,0-x1-Steckplätze
  - 3 x PCI-Steckplätze

- Audio**
- 5.1-Kanal-HD-Audio (Realtek ALC662-Audiocodec)
  - TI® NE5532 (unterstützt erstklassigen Headset-Verstärker mit bis zu 600 Ohm)

- LAN**
- PCIE x1 Gigabit LAN 10/100/1000 Mb/s
  - Realtek RTL8111G
  - Unterstützt Wake-On-LAN
  - Unterstützt LAN-Kabelerkennung
  - Unterstützt energieeffizientes Ethernet 802.3az
  - Unterstützt PXE

**Rückblende,  
E/A**

- 1 x PS/2-Mausanschluss
- 1 x PS/2-Tastaturanschluss
- 1 x Serieller port: COM1
- 1 x Parallel Port (ECP/EPP Support)
- 1 x Koaxial-SPDIF-Ausgang
- 4 x USB 2.0-Ports
- 2 x USB 3.0-Ports
- 1 x RJ-45-LAN-Port mit LED (Aktivität/Verbindung-LED und Geschwindigkeit-LED)
- HD-Audioanschluss: Line-in / Vorderer Lautsprecher / Mikrofon

**Speicher**

- 4 x SATA-III-6,0-Gb/s-Anschlüsse, unterstützt NCQ, AHCI und „Hot-Plugging“-Funktionen
- 2 x SATA-II-3,0-Gb/s-Anschlüsse, unterstützt NCQ, AHCI und „Hot-Plugging“-Funktionen

**Anschluss**

- 1 x IR-Stiftleiste
- 1 x Betrieb-LED-Stiftleiste
- 1 x TPM-Stiftleiste
- 2 x CPU-Lüfteranschlüsse (1 x 4-polig, 1 x 3-polig)
- 2 x Gehäuselüfteranschlüsse (1 x 4-polig, 1 x 3-polig)
- 1 x Netzteil Lüfteranschluss (3-polig)
- 1 x 24-poliger ATX-Netzanschluss
- 1 x 8-poliger 12-V-Netzanschluss
- 1 x Audioanschluss an Frontblende
- 1 x SPDIF-Ausgang
- 2 x USB 2.0-Stiftleisten (unterstützt vier USB 2.0-Ports)
- 1 x USB 3.0-Stiftleiste (unterstützt zwei USB 3.0-Ports)

**BIOS-  
Funktion**

- 64-Mb-AMI-UEFI-Legal-BIOS mit Unterstützung mehrsprachiger grafischer Benutzerschnittstellen
- ACPI 1.1-konforme Aufweckereignisse
- SMBIOS 2.3.1-Unterstützung
- CPU, DRAM, PCH 1,05 V / Mehrfachspannungsanpassung

**Support-CD**

- Treiber, Dienstprogramme, Antivirensoftware (Testversion), CyberLink MediaEspresso 6.5-Testversion, Google Chrome Browser und Toolbar, Start8

**Hardware-  
überwachung**

- CPU-/Gehäuse/Netzteiltemperaturerkennung
- CPU-/Gehäuse/Netzteil-Lüftertachometer
- Lautloser CPU-/Gehäuselüfter (ermöglicht automatische Anpassung der Geschwindigkeit des Gehäuselüfters über die CPU-Temperatur)
- CPU-/Gehäuselüfter-Mehrfachgeschwindigkeitssteuerung
- Spannungsüberwachung: +12 V, +5 V, +3,3 V, CPU Vcore

**Betriebssystem**

- Konform mit Microsoft® Windows® 8 / 8, 64 Bit / 7 / 7, 64 Bit

**Zertifizierungen**

- FCC, CE, WHQL
- ErP/EuP ready (ErP/EuP ready-Netzteil erforderlich)

\* Detaillierte Produktinformationen finden Sie auf unserer Webseite: <http://www.asrock.com>



Bitte beachten Sie, dass mit einer Übertaktung, zu der die Anpassung von BIOS-Einstellungen, die Anwendung der Untied Overclocking Technology oder die Nutzung von Übertaktungswerkzeugen von Drittanbietern zählen, bestimmte Risiken verbunden sind. Eine Übertaktung kann sich auf die Stabilität Ihres Systems auswirken und sogar Komponenten und Geräte Ihres Systems beschädigen. Sie sollte auf eigene Gefahr und eigene Kosten durchgeführt werden. Wir übernehmen keine Verantwortung für mögliche Schäden, die durch eine Übertaktung verursacht wurden.



Aufgrund von Beschränkungen kann die Größe des tatsächlich für die Systemnutzung reservierten Speichers unter Windows®-Betriebssystemen mit 32 Bit weniger als 4 GB betragen. Windows®-Betriebssysteme mit 64 Bit haben keine derartigen Beschränkungen. Mit ASRock XFast RAM können Sie den Speicher einsetzen, den Windows® nicht nutzen kann.

## 1.3 JumperEinstellung

Die Abbildung zeigt, wie die Jumper eingestellt werden. Wenn die Jumper-Kappe auf den Kontakten angebracht ist, ist der Jumper „kurzgeschlossen“. Wenn keine Jumper-Kappe auf den Kontakten angebracht ist, ist der Jumper „offen“. Die Abbildung zeigt einen 3-poligen Jumper, dessen Kontakt 1 und Kontakt 2 „kurzgeschlossen“ sind, wenn eine Jumper-Kappe auf diesen 2 Kontakten angebracht ist.

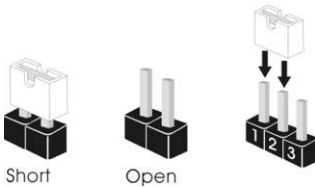

---

CMOS-löschen-Jumper  
(CLRCMOS1)  
(siehe S. 1, Nr. 25)



Standard



CMOS löschen

---

CLRCMOS1 ermöglicht Ihnen die Löschung der Daten im CMOS. Zum Löschen und Zurücksetzen der Systemparameter auf die Standardeinrichtung schalten Sie den Computer bitte ab und ziehen das Netzkabel aus der Steckdose. Warten Sie 15 Sekunde, schließen Sie dann Kontakt 2 und Kontakt 3 an CLRCMOS1 5 Sekunden lang mit einer Jumper-Kappe kurz. Löschen Sie den CMOS jedoch nicht direkt nach der BIOS-Aktualisierung. Falls Sie den CMOS direkt nach Abschluss der BIOS-Aktualisierung löschen müssen, starten Sie das System zunächst; fahren Sie es dann vor der CMOS-Löschung herunter. Bitte beachten Sie, dass Kennwort, Datum, Zeit und Benutzerstandardprofil nur gelöscht werden, wenn die CMOS-Batterie entfernt wird.

## 1.4 Integrierte Stiftleisten und Anschlüsse



Integrierte Stiftleisten und Anschlüsse sind KEINE Jumper. Bringen Sie KEINE Jumper-Kappen an diesen Stiftleisten und Anschlüssen an. Durch Anbringen von Jumper-Kappen an diesen Stiftleisten und Anschlüssen können Sie das Motherboard dauerhaft beschädigen.

Systemblende-Stiftleiste  
(9-polig, PANEL1)  
(siehe S. 1, Nr. 16)

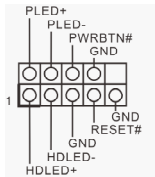

Verbinden Sie Netzschalter, Reset-Taste und Systemstatusanzeige am Gehäuse entsprechend der nachstehenden Pinbelegung mit dieser Stiftleiste. Beachten Sie vor Anschließen der Kabel die positiven und negativen Kontakte.



**PWRBTN (Ein-/Austaste):**

Mit der Ein-/Austaste an der Frontblende des Gehäuses verbinden. Sie können die Abschaltung Ihres Systems über die Ein-/Austaste konfigurieren.

**RESET (Reset-Taste):**

Mit der Reset-Taste an der Frontblende des Gehäuses verbinden. Starten Sie den Computer über die Reset-Taste neu, wenn er abstürzt oder sich nicht normal neu starten lässt.

**PLED (Systembetrieb-LED):**

Mit der Betriebsstatusanzeige an der Frontblende des Gehäuses verbinden. Die LED leuchtet, wenn das System läuft. Die LED blinkt, wenn sich das System im S1/S3-Ruhezustand befindet. Die LED ist aus, wenn sich das System im S4-Ruhezustand befindet oder ausgeschaltet ist (S5).

**HDLED (Festplattenaktivität-LED):**

Mit der Festplattenaktivität-LED an der Frontblende des Gehäuses verbinden. Die LED leuchtet, wenn die Festplatte Daten liest oder schreibt.

Das Design der Frontblende kann je nach Gehäuse variieren. Ein Frontblendenmodul besteht hauptsächlich aus Ein-/Austaste, Reset-Taste, Betrieb-LED, Festplattenaktivität-LED, Lautsprecher etc. Stellen Sie beim Anschließen Ihres Frontblendenmoduls an diese Stiftleiste sicher, dass Kabel- und Pinbelegung richtig abgestimmt sind.

Betrieb-LED-Stiftleiste  
(3-polig, PLED1)  
(siehe S. 1, Nr. 14)



Bitte verbinden Sie die Betrieb-LED des Gehäuses zur Anzeige des Systembetriebsstatus mit dieser Stiftleiste.

Serial-ATA-II-Anschlüsse  
(SATA2\_4:  
siehe S. 1, Nr. 13)  
(SATA2\_5:  
siehe S. 1, Nr. 12)



Diese beiden SATA-II-Anschlüsse unterstützen SATA-Datenkabel für interne Speichergeräte mit einer Datenübertragungsgeschwindigkeit bis 3,0 Gb/s.

Serial-ATA-III-Anschlüsse  
(SATA3\_0:  
siehe S. 1, Nr. 9)  
(SATA3\_1:  
siehe S. 1, Nr. 10)  
(SATA3\_2:  
siehe S. 1, Nr. 8)  
(SATA3\_3:  
siehe S. 1, Nr. 11)

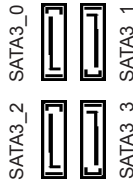

Diese vier SATA-III-Anschlüsse unterstützen SATA-Datenkabel für interne Speichergeräte mit einer Datenübertragungsgeschwindigkeit bis 6,0 Gb/s.

USB 2.0-Stiftleisten  
(9-polig, USB4\_5)  
(siehe S. 1, Nr. 20)  
(9-polig, USB6\_7)  
(siehe S. 1, Nr. 19)

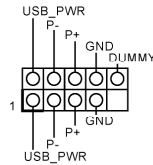

Neben vier USB 2.0-Ports an der E/A-Blende befinden sich zwei Stiftleisten an diesem Motherboard. Jede USB 2.0-Stiftleiste kann zwei Ports unterstützen.

USB 3.0-Stiftleiste  
(19-polig, USB3\_2\_3)  
(siehe S. 1, Nr. 7)

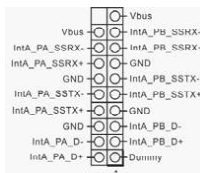

Neben zwei USB 3.0-Ports an der E/A-Blende befindet sich eine Stiftleiste an diesem Motherboard. Jede USB 3.0-Stiftleiste kann zwei Ports unterstützen.



**Audiostiftleiste**  
 (Frontblende)  
 (9-polig, HD\_AUDIO1)  
 (siehe S. 1, Nr. 23)

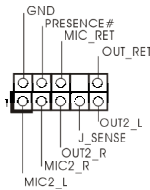

Diese Stiftleiste dient dem Anschließen von Audiogeräten an der Frontblende.



1. High Definition Audio unterstützt Anschlusserkennung, der Draht am Gehäuse muss dazu jedoch HDA unterstützen. Bitte befolgen Sie zum Installieren Ihres Systems die Anweisungen in unserer Anleitung und der Anleitung zum Gehäuse.
2. Wenn Sie ein AC'97-Audiopanel nutzen, installieren Sie es bitte anhand der nachstehenden Schritte an der Audiostiftleiste (Frontblende):
  - A. Verbinden Sie Mic\_IN (MIC) mit MIC2\_L.
  - B. Verbinden Sie Audio\_R (RIN) mit OUT2\_R und Audio\_L (LIN) mit OUT2\_L.
  - C. Verbinden Sie Erde (GND) mit Erde (GND).
  - D. MIC\_RET und OUT\_RET sind nur für das HD-Audio-Panel vorgesehen. Sie müssen Sie nicht mit dem AC'97-Audiopanel verbinden.
  - E. Rufen Sie zur Aktivierung des vorderen Mikrofons das „FrontMic (Frontmikrofon)“-Register in der Realtek-Systemsteuerung auf und passen „Recording Volume (Aufnahmelautstärke)“ an.

**Gehäuselautsprecherstiftleiste**  
 (4-polig, SPEAKER1)  
 (siehe S. 1, Nr. 15)

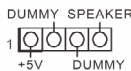

Bitte verbinden Sie den Gehäuselautsprecher mit dieser Stiftleiste.

**SPDIF-Ausgang**  
 (2-polig, SPDIF\_OUT1)  
 (siehe S. 1, Nr. 24)



Bitte verbinden Sie den SPDIF\_OUT-Anschluss einer HDMI-VGA-Karte über ein Kabel mit dieser Stiftleiste.

**Gehäuse- und Netzteil Lüfteranschlüsse**  
 (4-polig, CHA\_FAN1)  
 (siehe S. 1, Nr. 18)

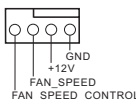

Bitte verbinden Sie die Lüfterkabel mit den Lüfteranschlüssen; der schwarze Draht gehört zum Erdungskontakt.

(4-polig, CHA\_FAN2)  
 (siehe S. 1, Nr. 17)



(3-polig, PWR\_FAN1)  
(siehe S. 1, Nr. 2)

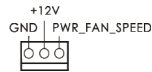

CPU-Lüfteranschlüsse  
(4-polig, CPU\_FAN1)  
(siehe S. 1, Nr. 3)

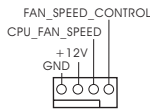

(3-polig, CPU\_FAN2)  
(siehe S. 1, Nr. 1)



Dieses Motherboard bietet einen 4-poligen CPU-Lüfteranschluss (lautloser Lüfter). Falls Sie einen 3-poligen CPU-Lüfter anschließen möchten, verbinden Sie ihn bitte mit Kontakt 1 bis 3.

ATX-Netzanschluss  
(24-polig, ATXPWR1)  
(siehe S. 1, Nr. 6)

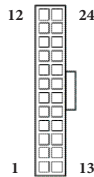

Dieses Motherboard bietet einen 24-poligen ATX-Netzanschluss. Bitte schließen Sie es zur Nutzung eines 20-poligen ATX-Netzteils entlang Kontakt 1 und Kontakt 13 an.

ATX-12-V-Netzanschluss  
(8-polig, ATX12V1)  
(siehe S. 1, Nr. 4)

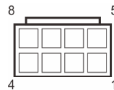

Dieses Motherboard bietet einen 8-poligen ATX-12-V-Netzanschluss. Bitte schließen Sie es zur Nutzung eines 4-poligen ATX-Netzteils entlang Kontakt 1 und Kontakt 5 an.

Infrarotmodul-Stiftleiste  
(5-polig, IR1)  
(siehe S. 1, Nr. 22)

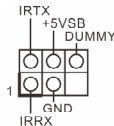

Diese Stiftleiste unterstützt ein optionales kabelloses Infrarotmodul zum Übertragen und Empfangen.

TPM-Stiftleiste  
(17-polig, TPMS1)  
(siehe S. 1, Nr. 21)

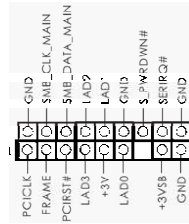

Dieser Anschluss unterstützt das Trusted Platform Module- (TPM) System, das Schlüssel, digitale Zertifikate, Kennwörter und Daten sicher aufbewahren kann. Ein TPM-System hilft zudem bei der Stärkung der Netzwerksicherheit, schützt digitale Identitäten und gewährleistet die Plattformintegrität.

# 1 Introduction

Nous vous remercions d'avoir acheté cette carte mère ASRock P85 Pro3, une carte mère fiable fabriquée conformément au contrôle de qualité rigoureux et constant appliqué par ASRock. Fidèle à son engagement de qualité et de durabilité, ASRock vous garantit une carte mère de conception robuste aux performances élevées.



*Les spécifications de la carte mère et du logiciel BIOS pouvant être mises à jour, le contenu de ce document est soumis à modification sans préavis. En cas de modifications du présent document, la version mise à jour sera disponible sur le site Internet ASRock sans notification préalable. Si vous avez besoin d'une assistance technique pour votre carte mère, veuillez visiter notre site Internet pour plus de détails sur le modèle que vous utilisez. La liste la plus récente des cartes VGA et des processeurs pris en charge est également disponible sur le site Internet de ASRock. Site Internet ASRock <http://www.asrock.com>.*

## 1.1 Contenu de l'emballage

- Carte mère ASRock P85 Pro3 (facteur de forme ATX)
- Guide d'installation rapide ASRock P85 Pro3
- CD d'assistance ASRock P85 Pro3
- 2 x câbles de données Serial ATA (SATA) (Optionnel)
- 1 x panneau de protection E/S

## 1.2 Spécifications

- |                          |  |
|--------------------------|--|
| <b>Plateforme</b>        | <ul style="list-style-type: none"> <li>• Facteur de forme ATX</li> <li>• Conception à condensateurs solides</li> </ul>   |
| <b>Processeur</b>        | <ul style="list-style-type: none"> <li>• Prend en charge les processeurs 4<sup>ème</sup> Génération Intel® Core™ i7 / i5 / i3 / Xeon® / Pentium® / Celeron® en package LGA1150</li> <li>• Conception Digi Power</li> <li>• Alimentation à 4 phases</li> <li>• Prend en charge la technologie Intel® Turbo Boost 2.0</li> </ul>                             |
| <b>Chipset</b>           | <ul style="list-style-type: none"> <li>• Intel® B85</li> <li>• Prend en charge Intel® Small Business Advantage 2.0</li> </ul>  |
| <b>Mémoire</b>           | <ul style="list-style-type: none"> <li>• Technologie mémoire double canal DDR3</li> <li>• 2 x fentes DIMM DDR3</li> <li>• Prend en charge les mémoires sans tampon non ECC DDR3 1600/1333/1066</li> <li>• Capacité max. de la mémoire système : 16Go (voir AVERTISSEMENT)</li> <li>• Prend en charge Intel® Extreme Memory Profile (XMP)1.3/1.2</li> </ul> |
| <b>Fente d'expansion</b> | <ul style="list-style-type: none"> <li>• 1 x fente PCI Express 3.0 x 16</li> <li>• 2 x fentes PCI Express 2.0 x 1</li> <li>• 3 x fentes PCI</li> </ul>   |
| <b>Audio</b>             | <ul style="list-style-type: none"> <li>• Audio 5.1 CH HD (codec audio Realtek ALC662)</li> <li>• TI® NE5532 (compatible Premium Headset Amplifier jusqu'à 600 Ohms)</li> </ul>   |
| <b>Réseau</b>            | <ul style="list-style-type: none"> <li>• PCIE x1 Gigabit LAN 10/100/1000 Mo/s</li> <li>• Realtek RTL8111G</li> <li>• Prend en charge la fonction Wake-On-LAN</li> <li>• Prise en charge de la détection de câble LAN</li> <li>• Prend en charge la fonction d'économie d'énergie Ethernet 802.3az</li> <li>• Prend en charge PXE</li> </ul>                |

**Connectique  
du panneau  
arrière**

- 1 x port souris PS/2
- 1 x port clavier PS/2
- 1 x port série: COM1
- 1 x port parallèle: Support ECP/EPP
- 1 x port de sortie coaxial SPDIF
- 4 x ports USB 2.0
- 2 x ports USB 3.0
- 1 x port RJ-45 LAN avec LED (LED ACT/LIEN et LED VITESSE)
- Connecteurs jack audio HD : entrée ligne / haut-parleur avant / microphone

**Stockage**

- 4 x connecteurs SATA3 6,0 Go/s, compatibles avec les fonctions NCQ, AHCI et « Hot Plug »
- 2 x connecteurs SATA2 3,0 Go/s, compatibles avec les fonctions NCQ, AHCI et « Hot Plug »

**Connectique**

- 1 x embase IR
- 1 x embase LED d'alimentation
- 1 x embase TPM
- 2 x connecteurs pour ventilateur de processeur (1 x 4 broches, 1 x 3 broches)
- 2 x connecteurs pour ventilateur de châssis (1 x 4 broches, 1 x 3 broches)
- 1 x connecteur pour ventilateur d'alimentation (3 broches)
- 1 x connecteur d'alimentation ATX 24 broches
- 1 x connecteur d'alimentation 12V 8 broches
- 1 x connecteur audio panneau frontal
- 1 x port sortie SPDIF
- 2 x embases USB 2.0 (pour 4 ports USB 2.0)
- 1 x embase USB 3.0 (pour 2 ports USB 3.0)

**BIOS**

- BIOS UEFI AMI 64Mo avec prise en charge d'interface graphique multilingue
- Compatible ACPI 1.1 Wake Up Events
- Prend en charge SMBIOS 2.3.1
- Réglage de la tension CPU, DRAM, PCH 1,05V

**CD inclus**

- Pilotes, utilitaires, logiciel AntiVirus (version d'évaluation), version d'essai CyberLink MediaEspresso 6.5, navigateur Google Chrome et barre d'outils, Start8

**Surveillance du matériel**

- Détection de la température du processeur/châssis/ventilateur
- Tachéomètre processeur/châssis/ventilateur d'alimentation
- Fonction ventilateur silencieux processeur/châssis Quiet Fan (permet au ventilateur du châssis d'adapter sa vitesse de rotation automatiquement en fonction de la température du processeur)
- Contrôle simultané des vitesse du ventilateur processeur/châssis
- Surveillance de la tension d'alimentation : +12V, +5V, +3,3V, CPU Vcore

**Système d'exploitation**

- Compatible Microsoft® Windows® 8 / 8 64-bit / 7 / 7 64-bits

**Certifications**

- FCC, CE, WHQL
- ErP/EuP Ready (alimentation ErP/EuP ready requise)

\* pour des informations détaillées de nos produits, veuillez visiter notre site : <http://www.asrock.com>



*Il est important de signaler que l'overclocking présente certains risques, incluant des modifications du BIOS, l'application d'une technologie d'overclocking déliée et l'utilisation d'outils d'overclocking développés par des tiers. La stabilité de votre système peut être affectée par ces pratiques, voire provoquer des dommages aux composants et aux périphériques du système. L'overclocking se fait à vos risques et périls. Nous ne pourrions en aucun cas être tenus pour responsables des dommages éventuels provoqués par l'overclocking.*



*En raison de limitations dues au système d'exploitation, la capacité de mémoire utilisée sous Windows® 32-bit peut être inférieure à 4 Go. Cette limitation ne concerne pas les systèmes d'exploitation Windows® 64-bit. Vous pouvez utiliser ASRock XFast RAM pour utiliser la mémoire dont Windows® ne peut se servir.*

### 1.3 Configuration des cavaliers (jumpers)

L'illustration ci-dessous vous renseigne sur la configuration des cavaliers (jumpers). Lorsque le capuchon du cavalier est installé sur les broches, le cavalier est 'court-circuité'. Si le capuchon du cavalier n'est pas installé sur les broches, le cavalier est 'ouvert'. L'illustration représente un cavalier à 3 broches dont les broches 1 et 2 sont « court-circuitées » si un capuchon de cavalier est posé sur ces 2 broches.

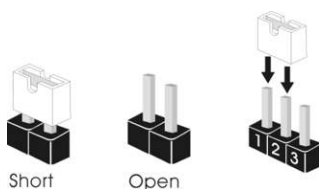

---

Cavalier Clear CMOS  
(CLRCMOS1)  
(voir p.1, No. 25)

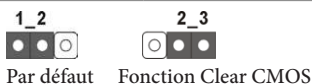

---

CLRCMOS1 vous permet d'effacer les données de la CMOS. Pour effacer les paramètres du système et rétablir les valeurs par défaut, veuillez éteindre votre ordinateur et débrancher son cordon d'alimentation. Patientez 15 secondes, puis utilisez un capuchon de cavalier pour court-circuiter la broche 2 et la broche 3 sur CLRCMOS1 pendant 5 secondes. Toutefois, n'effacez pas la CMOS immédiatement après avoir mis à jour le BIOS. Si vous avez besoin d'effacer les données CMOS après une mise à jour du BIOS, vous devez tout d'abord redémarrer le système, puis l'éteindre avant de procéder à l'effacement de la CMOS. Veuillez noter que les paramètres mot de passe, date, heure et profil de l'utilisateur seront uniquement effacés en cas de retrait de la pile de la CMOS.



## 1.4 Embases et connecteurs de la carte mère



Les embases et connecteurs situés sur la carte NE SONT PAS des cavaliers. Ne placez JAMAIS de capuchons de cavaliers sur ces embases ou connecteurs. Placer un capuchon de cavalier sur ces embases ou connecteurs endommagera irrémédiablement votre carte mère.

Embase du panneau système  
(PANNEAU1 à 9 broches)  
(voir p.1, No. 16)

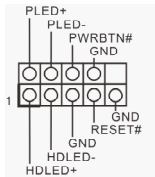

Branchez le bouton de mise en marche, le bouton de réinitialisation et le témoin d'état du système présents sur le châssis sur cette embase en respectant la configuration des broches illustrée ci-dessous. Repérez les broches positive et négative avant de brancher les câbles.



**PWRBTN (Bouton de mise en marche) :**

pour brancher le bouton de mise en marche au panneau frontal du châssis. Vous pouvez configurer la façon dont votre système doit s'arrêter à l'aide du bouton de mise en marche.

**RESET (Bouton de réinitialisation) :**

pour brancher le bouton de réinitialisation au panneau frontal du châssis. Appuyez sur le bouton de réinitialisation pour redémarrer l'ordinateur en cas de plantage ou de dysfonctionnement au démarrage.

**PLED (LED d'alimentation du système) :**

pour brancher le témoin d'état de l'alimentation au panneau frontal du châssis. Le LED est allumé lorsque le système fonctionne. Le LED clignote lorsque le système se trouve en mode veille S1/S3. Le LED est éteint lorsque le système se trouve en mode veille S4 ou hors tension (S5).

**HDLED (LED d'activité du disque dur) :**

pour brancher le témoin LED d'activité du disque dur au panneau frontal du châssis. Le LED est allumé lorsque le disque dur lit ou écrit des données.

La conception du panneau frontal peut varier en fonction du châssis. Un module de panneau frontal est principalement composé d'un bouton de mise en marche, bouton de réinitialisation, LED d'alimentation, LED d'activité du disque dur, haut-parleur etc. Lorsque vous reliez le module du panneau frontal de votre châssis sur cette embase, veillez à parfaitement faire correspondre les fils et les broches.

Embase LED  
d'alimentation  
(PLED1 à 3 broches)  
(voir p.1, No. 14)



Veillez brancher le  
LED d'alimentation  
du châssis sur cette  
embase pour indiquer  
l'état d'alimentation du  
système.

Connecteurs Serial ATA2  
(SATA2\_4:  
(voir p.1, No. 13)  
(SATA2\_5:  
(voir p.1, No. 12)



Ces deux connecteurs  
SATA2 sont compatibles  
avec les câbles de données  
SATA pour les appareils  
de stockage internes  
avec un taux de transfert  
maximal de 3,0 Go/s.

Connecteurs Serial ATA3  
(SATA3\_0:  
voir p.1, No. 9)  
(SATA3\_1:  
(voir p.1, No. 10)  
(SATA3\_2:  
(voir p.1, No. 8)  
(SATA3\_3:  
voir p.1, No. 11)

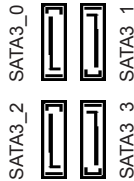

Ces quatre connecteurs  
SATA3 sont compatibles  
avec les câbles de données  
SATA pour les appareils  
de stockage internes  
avec un taux de transfert  
maximal de 6,0 Go/s.

Embases USB 2.0  
(USB4\_5 à 9 broches)  
(voir p.1, No. 20)  
(USB6\_7 à 9 broches)  
(voir p.1, No. 19)

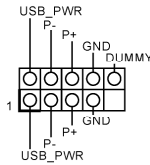

En plus des quatre ports  
USB 2.0 sur le panneau  
E/S, cette carte mère est  
dotée de deux embases.  
Chaque embase USB 2.0  
peut prendre en charge  
deux ports.

Embases USB 3.0  
(USB3\_2\_3 à 19 broches)  
(voir p.1, No. 7)

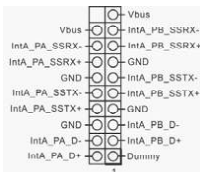

En plus des deux ports  
USB 3.0 sur le panneau  
E/S, cette carte mère  
est dotée d'une embase  
supplémentaire. Chaque  
embase USB 3.0 peut  
prendre en charge deux  
ports.

### Embase audio du panneau frontal

(HD\_AUDIO1 à 9 broches)  
(voir p.1, No. 23)

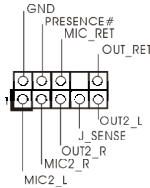

Cette embase sert au branchement des appareils audio au panneau audio frontal.



1. L'audio haute définition prend en charge la technologie Jack Sensing (détection de la fiche), mais le panneau grillagé du châssis doit être compatible avec la HDA pour fonctionner correctement. Veuillez suivre les instructions figurant dans notre manuel et dans le manuel du châssis pour installer votre système.
2. Si vous utilisez un panneau audio AC'97, veuillez le brancher sur l'embase audio du panneau frontal en procédant comme suit :
  - A. branchez Mic\_IN (MIC) sur MIC2\_L.
  - B. branchez Audio\_R (RIN) sur OUT2\_R et Audio\_L (LIN) sur OUT2\_L.
  - C. branchez la mise à terre (GND) sur mise à terre (GND).
  - D. MIC\_RET et OUT\_RET sont exclusivement réservés au panneau audio HD. Il est inutile de les brancher avec le panneau audio AC'97.
  - E. Pour activer le micro frontal, sélectionnez l'onglet « FrontMic » du panneau de contrôle Realtek et réglez le paramètre « Volume d'enregistrement ».

### Embase du haut-parleur du châssis

(SPEAKER1 à 4 broches)  
(voir p.1, No. 15)

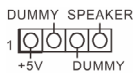

Veuillez brancher le haut-parleur du châssis sur cette embase.

### Connecteur sortie SPDIF

(SPDIF\_OUT1 à 2 broches)  
(voir p.1, No. 24)



Veuillez brancher le connecteur SPDIF\_OUT d'une carte VGA HDMI sur cette embase à l'aide d'un câble.

### Connecteurs du châssis et de l'alimentation du ventilateur

(CHA\_FAN1 à 4 broches)  
(voir p.1, No. 18)

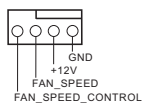

Veuillez brancher les câbles du ventilateur sur les connecteurs du ventilateur, puis reliez le fil noir à la broche de mise à terre.

(CHA\_FAN2 à 4 broches)  
(voir p.1, No. 17)



(PWR\_FAN1 à 3 broches)  
(voir p.1, No. 2)



Connecteurs du ventilateur du processeur (CPU\_FAN1 à 4 broches)  
(voir p.1, No. 3)

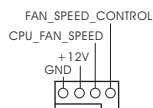

(CPU\_FAN2 à 3 broches)  
(voir p.1, No. 1)



Cette carte mère est dotée d'un connecteur pour ventilateur de processeur (Quiet Fan) à 4 broches. Si vous envisagez de connecter un ventilateur de processeur à 3 broches, veuillez le brancher sur la Broche 1-3.

Connecteur d'alimentation ATX (ATXPWR1 à 24 broches)  
(voir p.1, No. 6)

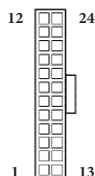

Cette carte mère est dotée d'un connecteur d'alimentation ATX à 24 broches. Pour utiliser une alimentation ATX à 20 broches, veuillez effectuer les branchements sur la Broche 1 et la Broche 13.

Connecteur d'alimentation ATX 12V (ATX12V1 à 8 broches)  
(voir p.1, No. 4)

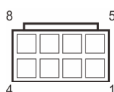

Cette carte mère est dotée d'un connecteur d'alimentation ATX 12V à 8 broches. Pour utiliser une alimentation ATX à 4 broches, veuillez effectuer les branchements sur la Broche 1 et la Broche 5.

Embase pour module infrarouge (IR1 à 5 broches)  
(voir p.1, No. 22)

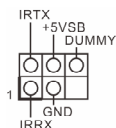

Cette embase prend en charge un module sans-fil d'émission et de réception infrarouge optionnel.

Embase TPM  
(TPMS1 à 17 broches)  
(voir p.1, No. 21)

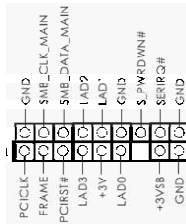

Ce connecteur prend en charge un module TPM (Trusted Platform Module – Module de plateforme sécurisée), qui permet de sauvegarder clés, certificats numériques, mots de passe et données en toute sécurité. Le système TPM permet également de renforcer la sécurité du réseau, de protéger les identités numériques et de préserver l'intégrité de la plateforme.

# 1 Introduzione

Grazie per aver acquistato la scheda madre P85 Pro3 ASRock, una scheda madre affidabile prodotta secondo i costanti e rigorosi controlli di qualità di ASRock.

La scheda madre offre eccellenti prestazioni con un design robusto che si adatta all'impegno di ASRock di offrire sempre qualità e durata.



*Dato che le specifiche della scheda madre e del software BIOS possono essere aggiornate, il contenuto di questa documentazione sarà soggetto a variazioni senza preavviso. Nel caso di eventuali modifiche della presente documentazione, la versione aggiornata sarà disponibile sul sito Web di ASRock senza ulteriore preavviso. Per il supporto tecnico correlato a questa scheda madre, visitare il nostro sito Web per informazioni specifiche relative al modello attualmente in uso. È possibile trovare l'elenco di schede VGA più recenti e di supporto di CPU anche sul sito Web di ASRock. Sito Web di ASRock <http://www.asrock.com>.*

## 1.1 Contenuto della confezione

- Scheda madre P85 Pro3 ASRock (fattore di forma ATX)
- Guida rapida di installazione P85 Pro3 ASRock
- CD di supporto P85 Pro3 ASRock
- 2 x cavi dati Serial ATA (SATA) (opzionali)
- 1 x mascherina metallica posteriore I/O

## 1.2 Specifiche

### Piattaforma

- Fattore di forma ATX
- Design di condensatore solido

### CPU

- Supporta Intel® Core™ i7 / i5 / i3 di 4a generazione / Xeon® / Pentium® / Celeron® in LGA1150 Package
- Design Digi Power
- 4 Power Phase Design
- Supporta la tecnologia Intel® Turbo Boost 2.0

### Chipset

- Intel® B85
- Supporta Intel® Small Business Advantage 2.0

### Memoria

- Tecnologia con memoria DDR3 a doppio canale
- 2 x slot DIMM DDR3
- Supporta la memoria DDR3 1600/1333/1066 non ECC, senza buffer
- Capacità max. della memoria di sistema: 16GB (si veda la sezione ATTENZIONE)
- Supporta Intel® Extreme Memory Profile (XMP)1.3/1.2

### Slot di espansione

- 1 x PCI Express 3.0 x16 slot
- 2 x PCI Express 2.0 x1 slot
- 3 x slot PCI

### Audio

- Audio HD a 5.1 canali (codec audio Realtek ALC662)
- TI® NE5532 (supporta l'amplificatore per cuffie di qualità superiore fino a 600 Ohm)

### LAN

- PCIE x 1 LAN Gigabit 10/100/1000 Mb/s
- Realtek RTL8111G
- Supporta Wake-On-LAN
- Supporta il rilevamento cavo LAN
- Supporta Energy Efficient Ethernet 802.3az
- Supporta PXE

**I/O pannello posteriore**

- 1 x porta mouse PS/2
- 1 x porta tastiera PS/2
- 1 x porta COM
- 1 x porta parallela: supporto ECP/EPP
- 1 x porta coassiale SPDIF Out
- 4 x porte USB 2.0
- 2 x porte USB 3.0
- 1 x porta LAN RJ-45 con LED (ACT/LINK LED e SPEED LED)
- Jack audio HD: ingresso linea/altoparlante anteriore/microfono

**Archiviazione**

- 4 x connettori SATA3 6,0 Gb/s, supporta le funzioni NCQ, AHCI e “Hot Plug”
- 2 x connettori SATA2 3,0 Gb/s, supporta le funzioni NCQ, AHCI e “Hot Plug”

**Connettore**

- 1 x header IR
- 1 x header LED di alimentazione
- 1 x header TPM
- 2 x connettori ventola CPU (1 x 4 pin, 1 x 3 pin)
- 2 x connettori ventola chassis (1 x 4 pin, 1 x 3 pin)
- 1 x connettore ventola alimentazione (3 pin)
- 1 x connettore alimentazione ATX a 24 pin
- 1 x connettore alimentazione da 12 V a 8 pin
- 1 x connettore audio pannello anteriore
- 1 x connettore uscita SPDIF
- 2 x header USB 2.0 (supporto 4 porte USB 2.0)
- 1 x header USB 3.0 (supporto 2 porte USB 3.0)

**Caratteristiche del BIOS**

- BIOS legale 64 Mb AMI UEFI con supporto GUI multilingue
- Eventi di wake up conformi ad ACPI 1.1
- Supporto SMBIOS 2.3.1
- Multiregolazione tensione CPU, DRAM, PCH 1,05 V

**CD di supporto**

- Driver, utilità, software antivirus (versione di prova), versione di prova di CyberLink MediaEspresso 6.5, browser e barra degli strumenti Google Chrome, Start8



**Hardware  
Monitor**

- Sensore temperatura CPU/chassis/ventola
- Tachimetro CPU/chassis/ventola alimentazione
- Ventola silenziosa CPU/chassis (consente l'autoregolazione della velocità della ventola dello chassis mediante la temperatura della CPU)
- Controllo multivelocità della ventola di CPU/chassis
- Monitoraggio tensione: +12 V, +5 V, +3,3 V, CPU Vcore

**SO**

- Microsoft® Windows® 8/8 a 64-bit/7/conforme a 7 a 64-bit

**Certificazioni**

- FCC, CE, WHQL
- ErP/EuP Ready (è necessaria alimentazione ErP/EuP ready)

\* Per informazioni dettagliate sul prodotto, visitare il nostro sito Web: <http://www.asrock.com>



*Prestare attenzione al potenziale rischio previsto nella pratica di overclocking, inclusa la regolazione delle impostazioni nel BIOS, l'applicazione di tecnologia di Untied Overclocking o l'utilizzo di strumenti di overclocking di terze parti. L'overclocking può influenzare la stabilità del sistema o perfino provocare danni ai componenti e ai dispositivi del sistema. Occorre eseguirlo a proprio rischio e spese. Non ci riterremo responsabili per possibili danni provocati da overclocking.*



*A causa della limitazione, l'effettiva dimensione della memoria può essere inferiore a 4 GB per riservare l'uso del sistema ai sistemi operativi di Windows® a 32 bit. I sistemi operativi Windows® a 64 bit non possiedono tali limitazioni. È possibile utilizzare la RAM XFast di ASRock per utilizzare la memoria che Windows® non può utilizzare.*

## 1.3 Impostazione jumper

L'illustrazione mostra in che modo vengono impostati i jumper. Quando il cappuccio del jumper è posizionato sui pin, il jumper è "cortocircuitato". Se sui pin non è posizionato alcun cappuccio del jumper, il jumper è "aperto". L'illustrazione mostra un jumper a 3 pin i cui pin1 e pin2 sono "cortocircuitati" quando un cappuccio del jumper è posizionato su questi 2 pin.

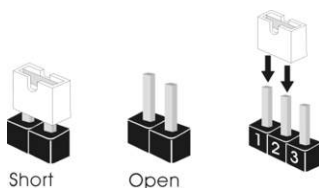

Jumper per azzerare la CMOS  
(CLRCMOS1)  
(vedere pag. 1, n. 25)



CLRCMOS1 consente di azzerare i dati presenti nella CMOS. Per azzerare e reimpostare i parametri del sistema alla configurazione predefinita, spegnere il computer e scollegare il cavo di alimentazione dalla rete. Dopo aver atteso 15 secondi, utilizzare un cappuccio del jumper per cortocircuitare il pin2 e il pin3 su CLRCMOS1 per 5 secondi. Tuttavia, non azzerare la CMOS subito dopo aver aggiornato il BIOS. Se è necessario azzerare la CMOS dopo l'aggiornamento del BIOS, è necessario riavviare prima il sistema e in seguito spegnerlo prima di eseguire l'operazione di azzeramento della CMOS. La password, la data, l'ora e il profilo predefinito dell'utente saranno azzerati solo se viene rimossa la batteria della CMOS.

## 1.4 Header e connettori sulla scheda



*Gli header e i connettori sulla scheda NON sono jumper. NON posizionare cappucci del jumper su questi header e connettori. Il posizionamento di cappucci del jumper su header e connettori provocherà danni permanenti alla scheda madre.*

Header sul pannello del sistema  
(PANEL1 a 9 pin)  
(vedere pag. 1, n. 16)

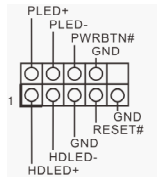

Collegare l'interruttore dell'alimentazione, l'interruttore di reset e l'indicatore dello stato del sistema sullo chassis su questo header secondo la seguente assegnazione dei pin. Annotare i pin positivi e negativi prima di collegare i cavi.



**PWRBTN (interruttore alimentazione):**

collegare all'interruttore dell'alimentazione sul pannello anteriore dello chassis. È possibile configurare il modo in cui spegnere il sistema utilizzando l'interruttore dell'alimentazione.

**RESET (interruttore di reset):**

collegare all'interruttore di reset sul pannello anteriore dello chassis. Premere l'interruttore di reset per riavviare il computer se il computer si blocca e non riesce ad eseguire un normale riavvio.

**PLED (LED alimentazione del sistema):**

collegare all'indicatore di stato dell'alimentazione sul pannello anteriore dello chassis. Il LED è acceso quando il sistema è in funzione. Il LED continua a lampeggiare quando il sistema si trova nello stato di sospensione S1/S3. Il LED è spento quando il sistema si trova nello stato di sospensione S4 o quando è spento (S5).

**HDLED (LED di attività disco rigido):**

collegare al LED di attività disco rigido sul pannello anteriore dello chassis. Il LED è acceso quando il disco rigido sta leggendo o scrivendo dati.

Il design del pannello anteriore può cambiare a seconda dello chassis. Un modulo di pannello anteriore è composto principalmente da interruttore di alimentazione, interruttore di reset, LED di alimentazione, LED di attività disco rigido, altoparlante, ecc. Quando si collega il modulo del pannello anteriore dello chassis a questo header, accertarsi che le assegnazioni del filo e le assegnazioni del pin corrispondano correttamente.

Header LED di alimentazione (PLED1 a 3 pin) (vedere pag. 1, n. 14)



Collegare il LED di alimentazione chassis a questo header per indicare lo stato di alimentazione del sistema.

Connettori Serial ATA2 (SATA2\_4: vedere pag. 1, n. 13) (SATA2\_5: vedere pag. 1, n. 12)



Questi due connettori SATA2 supportano i cavi dati SATA per dispositivi di archiviazione interna, con una velocità di trasferimento dati fino a 3,0 Gb/s.

Connettori Serial ATA3 (SATA3\_0: vedere pag.1, n. 9) (SATA3\_1: vedere pag. 1, n. 10) (SATA3\_2: vedere pag. 1, n. 8) (SATA3\_3: vedere pag.1, n. 11)

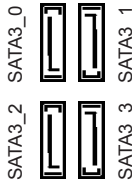

Questi quattro connettori SATA3 supportano cavi dati SATA per dispositivi di archiviazione interna, con una velocità di trasferimento dati fino a 6,0 Gb/s.

Header USB 2.0 (USB4\_5 a 9 pin) (vedere pag. 1, n. 20) (USB6\_7 a 9 pin) (vedere pag. 1, n. 19)

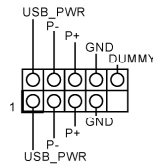

Oltre alle quattro porte USB 2.0 sul pannello I/O, su questa scheda madre vi sono due header. Ciascun header USB 2.0 può supportare due porte.

Header USB 3.0 (USB3\_2\_3 a 19 pin) (vedere pag. 1, n. 7)

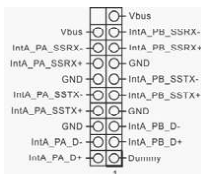

Oltre alle due porte USB 3.0 sul pannello I/O, su questa scheda madre vi è un header. Ciascun header USB 3.0 può supportare due porte.

Header audio pannello anteriore  
(AUDIO1\_HD a 9 pin)  
(vedere pag. 1, n. 23)

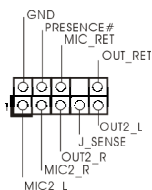

Questo header serve a collegare i dispositivi audio al pannello audio anteriore.



1. L'audio ad alta definizione supporta le funzioni Jack sensing, ma il filo del pannello sullo chassis deve supportare HDA per funzionare correttamente. Seguire le istruzioni presenti nel nostro manuale e nel manuale dello chassis per installare il sistema.
2. Se si utilizza un pannello audio AC'97, installarlo sull'header audio del pannello anteriore seguendo le fasi di seguito:
  - A. Collegare Mic\_IN (MIC) a MIC2\_L.
  - B. Collegare Audio\_R (RIN) a OUT2\_R e Audio\_L (LIN) a OUT2\_L.
  - C. Collegare Ground (GND) a Ground (GND).
  - D. MIC\_RET e OUT\_RET servono soltanto per il pannello audio HD. Non è necessario collegarli per il pannello audio AC'97.
  - E. Per attivare il microfono anteriore, andare alla scheda "MicAnt" nel pannello di controllo Realtek e regolare il "Volume di registrazione".

Header altoparlante chassis  
(SPEAKER1 a 4 pin)  
(vedere pag. 1, n. 15)



Collegare l'altoparlante dello chassis a questo header.

Connettore uscita SPDIF  
(SPDIF\_OUT1 a 2 pin)  
(vedere pag. 1, n. 24)



Collegare il connettore SPDIF\_OUT di una scheda VGA HDMI a questo header con un cavo.

Connettori ventola dello chassis e di alimentazione  
(CHA\_FAN1 a 4 pin)  
(vedere pag. 1, n. 18)

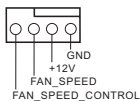

Collegare i cavi della ventola ai connettori della ventola e far corrispondere il filo nero al pin di terra.

(CHA\_FAN2 a 4 pin)  
(vedere pag. 1, n. 17)



(PWR\_FAN1 a 3 pin)  
(vedere pag. 1, n. 2)

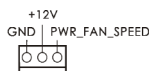

Connettori della ventola  
della CPU

(CPU\_FAN1 a 4 pin)  
(vedere pag. 1, n. 3)

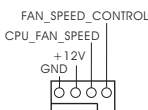

(CPU\_FAN2 a 3 pin)  
(vedere pag. 1, n. 1)



Questa scheda madre è dotata di un connettore per la ventola della CPU (Ventola silenziosa) a 4 pin. Se si decide di collegare una ventola della CPU a 3 pin, collegarla al pin 1-3.

Connettore di  
alimentazione ATX  
(ATXPWR1 a 24 pin)  
(vedere pag. 1, n. 6)

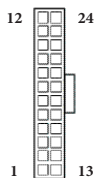

Questa scheda madre è dotata di un connettore di alimentazione ATX a 24 pin. Per utilizzare un'alimentazione ATX a 20 pin, collegarla lungo il pin1 e il pin 13.

Connettore di  
alimentazione ATX da 12 V  
(ATX12V1 a 8 pin)  
(vedere pag. 1, n. 4)

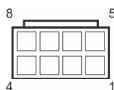

Questa scheda madre è dotata di un connettore di alimentazione ATX da 12 V a 8 pin. Per utilizzare un'alimentazione ATX a 4 pin, collegarla lungo il pin1 e il pin 5.

Header modulo infrarossi  
(IR1 a 5 pin)  
(vedere pag. 1, n. 22)

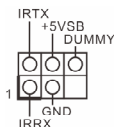

Questo header supporta un modulo infrarossi di trasmissione e ricezione wireless opzionale.

Header TPM  
(TPMS1 a 17 pin)  
(vedere pag. 1, n. 21)

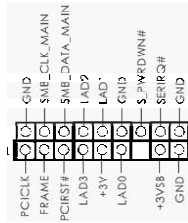

Questo connettore supporta il sistema Trusted Platform Module (TPM), che può archiviare in modo sicuro chiavi, certificati digitali, password e dati. Un sistema TPM permette anche di potenziare la sicurezza della rete, di proteggere identità digitali e di garantire l'integrità della piattaforma.

# 1 Introducción

Gracias por comprar la placa base ASRock P85 Pro3, una placa base fiable fabricada según el rigurosísimo control de calidad de ASRock. Ofrece un rendimiento excelente con un diseño resistente de acuerdo con el compromiso de calidad y resistencia de ASRock.



*Ya que las especificaciones de la placa base y el software del BIOS podrán ser actualizados, el contenido que aparece en esta documentación estará sujeto a modificaciones sin previo aviso. Si esta documentación sufre alguna modificación, la versión actualizada estará disponible en el sitio web de ASRock sin previo aviso. Si necesita asistencia técnica relacionada con esta placa base, visite nuestro sitio web para obtener información específica sobre el modelo que esté utilizando. Podrá encontrar las últimas tarjetas VGA, así como la lista de compatibilidad de la CPU, en el sitio web de ASRock. Sitio web de ASRock <http://www.asrock.com>.*

## 1.1 Contenido del paquete

- Placa base ASRock P85 Pro3 (Factor de forma ATX)
- Guía de instalación rápida de ASRock P85 Pro3
- CD de soporte de ASRock P85 Pro3
- 2 cables de datos Serie ATA (SATA) (Opcional)
- 1 escudo panel I/O



## 1.2 Especificaciones

- |                            |  |
|----------------------------|--|
| <b>Plataforma</b>          | <ul style="list-style-type: none"> <li>• Factor de forma ATX</li> <li>• Diseño de los Condensadores: All Solid</li> </ul>  |
| <b>CPU</b>                 | <ul style="list-style-type: none"> <li>• Compatible con 4.ª Generación de Intel® Core™ i7 / i5 / i3 / Xeon® / Pentium® / Celeron® en paquete LGA1150</li> <li>• Diseño Digi Power</li> <li>• Diseño de 4 fases de alimentación</li> <li>• Compatible con la tecnología de Intel® Turbo Boost 2.0</li> </ul>  |
| <b>Conjunto de chips</b>   | <ul style="list-style-type: none"> <li>• Intel® B85</li> <li>• Compatible con Intel® Small Business Advantage 2.0</li> </ul>   |
| <b>Memoria</b>             | <ul style="list-style-type: none"> <li>• Tecnología de memoria de Doble Canal DDR3</li> <li>• 2 ranuras DDR3 DIMM</li> <li>• Compatible con memoria no-ECC, sin búfer DDR3 1600/1333/1066</li> <li>• Capacidad máxima de la memoria del sistema: 16GB (consulte la ADVERTENCIA)</li> <li>• Compatible con Extreme Memory Profile (XMP)1.3/1.2 de Intel®</li> </ul> |
| <b>Ranura de expansión</b> | <ul style="list-style-type: none"> <li>• 1 ranura PCI Express 3.0 x16</li> <li>• 2 ranuras PCI Express 2.0 x1</li> <li>• 3 ranuras PCI</li> </ul>  |
| <b>Audio</b>               | <ul style="list-style-type: none"> <li>• 5.1 Audio CH HD (Realtek ALC662 Audio Codec)</li> <li>• TI® NE5532 (compatible con Amplificador de Auriculares Premium de hasta 600 ohmios)</li> </ul>  |
| <b>LAN</b>                 | <ul style="list-style-type: none"> <li>• 1 LAN Gigabit PCIE 10/100/1000 Mb/s</li> <li>• Realtek RTL8111G</li> <li>• Compatible con Wake-On-LAN</li> <li>• Admite detección de conexión de cable LAN</li> <li>• Compatible con Ethernet de consumo eficiente de energía 802.3az</li> <li>• Compatible con PXE</li> </ul>  |

## **Panel trasero I/O**

- 1 puerto de ratón PS/2
- 1 puerto de teclado PS/2
- 1 puerto serial: COM1
- 1 puerto paralelo: soporta ECP/EPP
- 1 puerto de salida coaxial SPDIF
- 4 puertos USB 2.0
- 2 puertos USB 3.0
- 1 puerto LAN RJ-45 con LED (ACT/LINK LED y SPEED LED)
- Conector de audio HD: Entrada de línea / Altavoz frontal / Micrófono

## **Almacenamiento**

- 4 conectores SATA3 de 6,0 Gb/s, compatibles con las funciones NCQ, AHCI y “Hot Plug”
- 2 conectores SATA2 de 3,0 Gb/s, compatibles con las funciones NCQ, AHCI y “Hot Plug”

## **Conectores**

- 1 cabezal IR
- 1 cabezal de indicador LED de alimentación
- 1 cabezal TPM
- 2 conectores de ventilador de la CPU (1 de 4 pines y 1 de 3 pines)
- 2 conectores de ventilador del chasis (1 de 4 pines y 1 de 3 pines)
- 1 conector de ventilador de alimentación (de 3 pines)
- 1 conector de alimentación ATX de 24 pines
- 1 conector de alimentación de 12V de 8 pines
- 1 conector de audio del panel frontal
- 1 conector de salida SPDIF
- 2 cabezales USB 2.0 (compatibles con 4 puertos USB 2.0)
- 1 cabezal USB 3.0 (compatible con 2 puertos USB 3.0)

## **Características del BIOS**

- BIOS legal UEFI AMI de 64Mb compatible con interfaz gráfica de usuario multilingüe
- Eventos de reactivación conformes con ACPI 1.1
- Compatible con SMBIOS 2.3.1
- Multiajuste de voltaje de CPU, DRAM, PCH 1,05V

## **CD de soporte**

- Controladores, Utilidades, Software AntiVirus (Versión de prueba), Versión de prueba de CyberLink MediaEspresso 6.5, Explorador y Barra de herramientas de Google Chrome y Start8

**Monitor del hardware**

- Método de sensor de temperatura de la alimentación/CPU/Chasis
- Tacómetro del ventilador de alimentación/CPU/Chasis
- Ventilador silencioso de la CPU/Chasis (permite ajustar automáticamente la velocidad del ventilador del chasis mediante la temperatura de la CPU)
- Control multivelocidad del ventilador de la CPU/Chasis
- Control del voltaje: +12V, +5V, +3,3V, CPU Vcore

**SO**

- Compatible con Microsoft® Windows® 8 / 8 de 64 bits / 7 / 7 de 64 bits

**Certificaciones**

- FCC, CE, WHQL
- Compatible con ErP/EuP (requiere toma de alimentación compatible con ErP/EuP)

\* Para obtener más información acerca del producto, visite nuestro sitio web: <http://www.asrock.com>



*Tenga en cuenta que existen ciertos riesgos relacionados con el overlocking (sobreceleración), incluyendo el ajuste de la configuración del BIOS, aplicando la Tecnología overlocking no vinculada o utilizando las herramientas de overlocking de tercera parte. El overlocking podría afectar la estabilidad de su sistema o incluso dañar los componentes y dispositivos de su sistema. Si lo realiza, todos los riesgos y gastos derivados del overlocking serán de su entera responsabilidad. No nos hacemos responsables de posibles daños producidos por el overlocking.*



*Debido a las limitaciones, el tamaño real de la memoria podrá ser inferior a 4GB para reservar espacio para el uso del sistema en sistemas operativos Windows® de 32 bits. Los sistemas operativos Windows® de 64 bits no tienen estas limitaciones. Podrá utilizar XFast RAM de ASRock para usar la memoria que Windows® no puede utilizar.*

### 1.3 Instalación de los puentes

La instalación muestra cómo deben instalarse los puentes. Cuando la tapa de puente se coloca en los pines, el puente queda “Corto”. Si no coloca la tapa de puente en los pines, el puente queda “Abierto”. La ilustración muestra un puente de 3 pines cuyo pin 1 y pin 2 son “Cortos” cuando se coloca una tapa de puente en estos 2 pines.

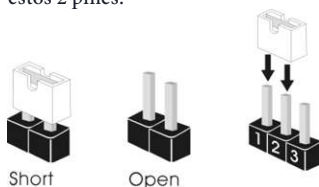

---

Puente de borrado de CMOS  
(CLRCMOS1)  
(consulte la pág.1, N.º 25)



---

CLRCMOS1 le permite borrar los datos del CMOS. Para borrar y restablecer los parámetros del sistema a los valores predeterminados de instalación, apague el ordenador y desenchufe el cable de alimentación de la toma de alimentación. Después de esperar 15 segundos, utilice un tapa de puente para acortar el pin2 y el pin3 en el CLRCMOS1 durante 5 segundos. Sin embargo, no borre el CMOS justo después de que haya actualizado el BIOS. Si necesita borrar el CMOS cuando acabe de actualizar el BIOS, deberá arrancar el sistema primero y, a continuación, deberá apagarlo antes de que realice el borrado del CMOS. Tenga en cuenta que la contraseña, la fecha, la hora y el perfil de usuario predeterminado serán eliminados únicamente si se retira la pila del CMOS.

## 1.4 Conectores y cabezales incorporados



Los cabezales y conectores incorporados NO son puentes. NO coloque tapas de puente sobre estos cabezales y conectores. Si coloca tapas de puente sobre los cabezales y conectores dañará de forma permanente la placa base.

Cabezal del panel del sistema  
(PANEL1 de 9 pines)  
(consulte la pág.1, N.º 16)

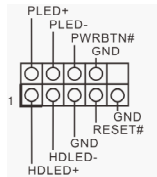

Conecte el interruptor de alimentación, restablezca el interruptor y el indicador del estado del sistema del chasis a los valores de este cabezal, según los valores asignados a los pines como se indica a continuación. Cerciórese de cuáles son los pines positivos y los negativos antes de conectar los cables.



**PWRBTN (Interruptor de alimentación):**

conéctelo al interruptor de alimentación del panel frontal del chasis. Deberá configurar la forma en la que su sistema se apagará mediante el interruptor de alimentación.

**RESET (Interruptor de reseteo):**

conéctelo al interruptor de reseteo del panel frontal del chasis. Pulse el interruptor de reseteo para resetear el ordenador si éste está bloqueado y no se puede reiniciar de forma normal.

**PLED (Indicador LED de alimentación del sistema):**

conéctelo al indicador del estado de la alimentación del panel frontal del chasis. El indicador LED permanece encendido cuando el sistema está funcionando. El indicador LED parpadea cuando el sistema se encuentra en estado de suspensión S1/S3. El indicador LED se apaga cuando el sistema se encuentra en estado de suspensión S4 o está apagado (S5).

**HDLED (Indicador LED de actividad en el disco duro):**

conéctelo al indicador LED de actividad en el disco duro del panel frontal del chasis. El indicador LED permanece encendido cuando el disco duro está leyendo o escribiendo datos.

El diseño del panel frontal puede ser diferente dependiendo del chasis. Un módulo de panel frontal consta principalmente de: interruptor de alimentación, interruptor de reseteo, indicador LED de alimentación, indicador LED de actividad en el disco duro, altavoz, etc. Cuando conecte su módulo del panel frontal del chasis a este cabezal, asegúrese de que las asignaciones de los cables y los pines coinciden correctamente.

Cabezal de indicador  
LED de alimentación  
(PLED1 de 3 pines)  
(consulte la pág.1, N.º 14)



Conecte el indicador LED de alimentación del chasis a este cabezal para indicar el estado de alimentación del sistema.

Conectores Serie ATA2  
(SATA2\_4:  
consulte la pág.1, N.º 13)  
(SATA2\_5:  
consulte la pág.1, N.º 12)



Estos dos conectores SATA2 son compatibles con cables de datos SATA para dispositivos de almacenamiento interno con una velocidad de transferencia de datos de hasta 3,0 Gb/s.

Conectores Serie ATA3  
(SATA3\_0:  
consulte la pág.1, N.º 9)  
(SATA3\_1:  
consulte la pág.1, N.º 10)  
(SATA3\_2:  
consulte la pág.1, N.º 8)  
(SATA3\_3:  
consulte la pág.1, N.º 11)

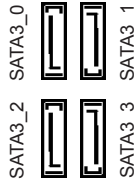

Estos cuatro conectores SATA3 son compatibles con cables de datos SATA para dispositivos de almacenamiento interno con una velocidad de transferencia de datos de hasta 6,0 Gb/s.

Cabezales USB 2.0  
(USB4\_5 de 9 pines)  
(consulte la pág.1, N.º 20)  
(USB6\_7 de 9 pines)  
(consulte la pág.1, N.º 19)

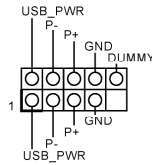

Además de cuatro puertos USB 2.0 en el panel I/O, esta placa base contiene dos cabezales. Cada cabezal USB 2.0 admite dos puertos.

Cabezal USB 3.0  
(USB3\_2\_3 de 19 pines)  
(consulte la pág.1, N.º 7)

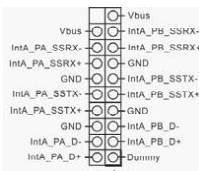

Además de dos puertos USB 3.0 en el panel I/O, esta placa base contiene un cabezal. Cada cabezal USB 3.0 admite dos puertos.

**Cabezal de audio del panel frontal**  
**(HD\_AUDIO1 de 9 pines)**  
 (consulte la pág.1, N.º 23)

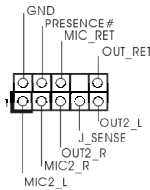

Este cabezal se utiliza para conectar dispositivos de audio al panel de audio frontal.



1. El Audio de Alta Definición (HDA, en inglés) es compatible con el método de sensor de conectores, sin embargo, el cable del panel del chasis deberá ser compatible con HDA para que pueda funcionar correctamente. Siga las instrucciones que se indican en nuestro manual y en el manual del chasis para instalar su sistema.
2. Si utiliza un panel de audio AC'97, instálelo en el cabezal de audio del panel frontal siguiendo los siguientes pasos:
  - A. Conecte Mic\_IN (MIC) a MIC2\_L.
  - B. Conecte Audio\_R (RIN) a OUT2\_R y Audio\_L (LIN) a OUT2\_L.
  - C. Conecte Ground (conexión a tierra) (GND) a Ground (GND).
  - D. MIC\_RET y OUT\_RET se utilizan únicamente para el panel de audio HD. No es necesario que los conecte en el panel de audio AC'97.
  - E. Para activar el micrófono frontal, vaya a la ficha "micrófono frontal" (FrontMic) en el panel de control de Realtek y ajuste el "Volumen de grabación" (Recording Volume).

**Cabezal de altavoces del chasis**  
**(SPEAKER1 de 4 pines)**  
 (consulte la pág.1, N.º 15)

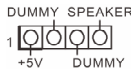

Conecte el altavoz del chasis a este cabezal.

**Conector de salida SPDIF**  
**(SPDIF\_OUT1 de 2 pines)**  
 (consulte la pág.1, N.º 24)



Conecte el conector SPDIF\_OUT de una tarjeta VGA HDMI a este cabezal con un cable.

**Conectores del ventilador de alimentación y del chasis**  
**(CHA\_FAN1 de 4 pines)**  
 (consulte la pág.1, N.º 18)

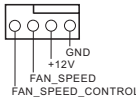

Conecte los cables del ventilador a los conectores del ventilador y haga coincidir el cable negro con el pin de conexión a tierra.

**(CHA\_FAN2 de 4 pines)**  
 (consulte la pág.1, N.º 17)



(PWR\_FAN1 de 3 pines)  
(consulte la pág.1, N.º 2)

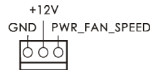

Conectores del ventilador  
de la CPU  
(CPU\_FAN1 de 4 pines)  
(consulte la pág.1, N.º 3)

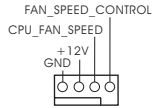

(CPU\_FAN2 de 3 pines)  
(consulte la pág.1, N.º 1)



Esta placa base contiene un conector de ventilador (ventilador silencioso) de CPU de 4 pines. Si tiene pensando conectar un ventilador de CPU de 3 pines, conéctelo al Pin 1-3.

Conector de alimentación  
ATX  
(ATXPWR1 de 24 pines)  
(consulte la pág.1, N.º 3)

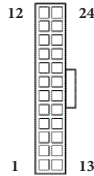

Esta placa base contiene un conector de alimentación ATX de 24 pines. Para utilizar una toma de alimentación ATX de 20 pines, conéctela en los Pines del 1 al 13.

Conector de alimentación  
ATX de 12V  
(ATX12V1 de 8 pines)  
(consulte la pág.1, N.º 4)

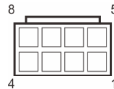

Esta placa base contiene un conector de alimentación ATX de 12V y 8 pines. Para utilizar una toma de alimentación ATX de 4 pines, conéctela en los Pines del 1 al 5.

Cabezal de módulo  
infrarrojo  
(IR1 de 5 pines)  
(consulte la pág.1, N.º 22)

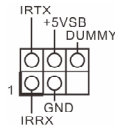

Este cabezal admite un módulo infrarrojo opcional de transmisión y recepción inalámbrico.



Cabezal TPM  
(TPMS1 de 17 pines)  
(consulte la pág.1, N.º 21)

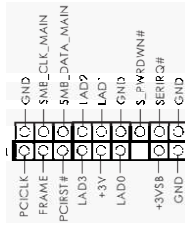

Este conector es compatible con el sistema Módulo de Plataforma Segura (TPM, en inglés), que puede almacenar de forma segura claves, certificados digitales, contraseñas y datos. Un sistema TPM también ayuda a aumentar la seguridad en la red, protege identidades digitales y garantiza la integridad de la plataforma.

# 1 Введение

Благодарим вас за приобретение надежной материнской платы ASRock P85 Pro3, выпускаемой под постоянным строгим контролем компании ASRock. Эта материнская плата обеспечивает великолепную производительность и характеризуется прочной конструкцией в соответствии с требованиями компании ASRock в отношении качества и долговечности.



*По причине обновления спецификации на материнскую платформу и программного обеспечения BIOS содержимое настоящей документации может быть изменено без предварительного уведомления. При изменении содержимого настоящего документа его обновленная версия будет доступна на веб-сайте ASRock без предварительного уведомления. При необходимости технической поддержки, связанной с материнской платой, посетите веб-сайт и найдите на нем информацию о модели используемой вами материнской платы. На веб-сайте ASRock также можно найти самый последний перечень поддерживаемых VGA-карт и ЦП. Веб-сайт ASRock <http://www.asrock.com>.*

## 1.1 Комплект поставки

- Материнская плата ASRock P85 Pro3 (форм-фактор ATX)
- Краткое руководство по установке ASRock P85 Pro3
- Диск с ПО для ASRock P85 Pro3
- 2 х кабеля передачи данных Serial ATA (SATA) (приобретаются отдельно)
- 1 х экран панели с портами ввода-вывода

## 1.2 Спецификация

<b>Платформа</b>	<ul style="list-style-type: none"> <li>• Форм-фактор ATX</li> <li>• Использование только твердотельных конденсаторов</li> </ul>
<b>ЦП</b>	<ul style="list-style-type: none"> <li>• Поддержка процессоров 4-го поколения Intel® Core™ i7 / i5 / i3 / Xeon® / Pentium® / Celeron® в исполнении LGA1150</li> <li>• Digi Power Design</li> <li>• Система питания 4</li> <li>• Поддержка технологии Intel® Turbo Boost 2.0</li> </ul>
<b>Чипсет</b>	<ul style="list-style-type: none"> <li>• Intel® B85</li> <li>• Поддержка Intel® Small Business Advantage 2.0</li> </ul>
<b>Память</b>	<ul style="list-style-type: none"> <li>• Двухканальная память DDR3</li> <li>• 2 x гнездо DDR3 DIMM</li> <li>• Поддержка модулей памяти DDR3 1600/1333/1066 Non-ECC Unbuffered</li> <li>• Максимальный объем системной памяти: 16 Гб (см. «ПРЕДОСТЕРЕЖЕНИЕ»)</li> <li>• Поддержка Intel® Extreme Memory Profile (XMP)1.3/1.2</li> </ul>
<b>Гнезда расширения</b>	<ul style="list-style-type: none"> <li>• 1 x PCI Express 3.0 x16 гнезд</li> <li>• 2 x PCI Express 2,0 x1</li> <li>• 3 x гнездо PCI</li> </ul>
<b>Аудио</b>	<ul style="list-style-type: none"> <li>• 5.1-канальный звук высокой четкости HD Audio (аудиокодек Realtek ALC662)</li> <li>• TP® NE5532 (поддержка усилителя Premium Headset Amplifier до 600 Ом)</li> </ul>
<b>ЛВС</b>	<ul style="list-style-type: none"> <li>• PCIE x1 Gigabit LAN 10/100/1000 Мб/с</li> <li>• Realtek RTL8111G</li> <li>• Поддержка Wake-On-LAN</li> <li>• Поддержка определения кабеля ЛВС</li> <li>• Поддержка Energy Efficient Ethernet 802.3az</li> <li>• Поддержка PXE</li> </ul>

**Порты  
ввода-  
вывода  
на задней  
панели**

- 1 x PS/2 мышь
- 1 x PS/2 для клавиатуры
- 1 x порт COM1
- 1 x параллельный порт: поддержка ECP/EPP
- 1 x порт Coaxial SPDIF Out
- 4 x USB 2.0
- 2 x USB 3.0
- 1 x RJ-45 для ЛВС с СИД (СИД АСТ/LINK и МИД SPEED)
- Разъемы HD Audio: линейный вход / передние динамики / микрофон

**Запоминающие  
устройства**

- 4 x разъем SATA3 6,0 Гб/с, поддержка функций NCQ, AHCI и «горячей» замены
- 2 x разъем SATA2 3,0 Гб/с, поддержка функций NCQ, AHCI и «горячей» замены

**Разъемы**

- 1 x колодка IR
- 1 x колодка светодиодного индикатора питания
- 1 x колодка TPM
- 2 x разъем для вентилятора ЦП (1 x 4-контактный, 1 x 3-контактный)
- 2 x разъема для вентилятора корпуса (1 x 4-контактный, 1 x 3-контактный)
- 1 x разъем для вентилятора блока питания (3-контактный)
- 1 x разъем питания ATX (24-контактный)
- 1 x 8-контактный разъем питания 12 В
- 1 x аудиоразъем на передней панели
- 1 x выходной разъем SPDIF
- 2 x колодки USB 2.0 (поддержка 4 портов USB 2.0)
- 1 x колодка USB 3.0 (поддержка 2 портов USB 3.0)

**Особенности  
BIOS**

- 64 Мб AMI UEFI Legal BIOS с поддержкой многоязычного ГИП
- Совместимость с управлением энергопотреблением по ACPI 1.1
- Поддержка SMBIOS 2.3.1
- Регулировка напряжений ЦП, DRAM, PCN 1,05 В

**Диск с ПО**

- Драйвера, утилиты, антивирусное ПО (демоверсия), CyberLink MediaEspresso 6.5 (демоверсия), браузер и панель инструментов Google Chrome, Start8

**Контроль  
оборудования**

- Датчик температуры ЦП/корпуса/блока питания
- Тахометр вентиляторов ЦП/корпуса/блока питания
- Малошумящий вентилятор ЦП/корпуса (с автоматической регулировкой оборотов по температуре ЦП)
- Управление оборотами вентилятора ЦП/корпуса
- Контроль напряжения: +12 В, +5 В, +3,3 В, ЦП Vcore

**ОС**

- Microsoft® Windows® 8 / 8 64-разрядная / 7 / 7 64-разрядная

**Сертификация**

- FCC, CE, WHQL
- Совместимость с ErP/EuP (необходим блок питания, соответствующий стандарту ErP/EuP)

\* Для получения дополнительной информации об изделии посетите наш веб-сайт:  
<http://www.asrock.com>



Следует учитывать, что разгон процессора, включая изменение настроек BIOS, применение технологии Untied Overclocking Technology и использование инструментов разгона независимых производителей, сопряжен с определенным риском. Разгон процессора может повлиять на стабильность системы или даже привести к повреждению ее компонентов и устройств. Вы выполняете разгон процессора на ваш собственный риск и за свой счет. Мы не несем ответственность за возможный ущерб, вызванный разгоном процессора.



В связи с ограничением при работе под 32-разрядной ОС Windows® фактический объем памяти может быть меньше 4 Гбайт. Для 64-разрядных ОС Windows® таких ограничений нет. Для использования той памяти, которую ОС Windows® не может использовать, используйте ASRock XFast RAM.

### 1.3 Установка перемычек

Установка перемычек показана на рисунке. При установке колпачковой перемычки на контакты перемычка «замкнута». Если колпачковая перемычка на контакты не установлена, перемычка «разомкнута». На рисунке показана 3-контактная перемычка с замкнутыми контактами 1 и 2 при установке на них колпачковой перемычки.

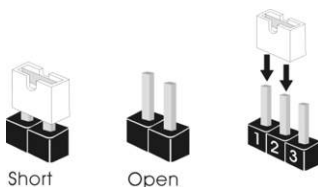

Перемычка сброса  
настроек CMOS  
(CLRCMOS1)  
(См. стр. 1, № 25)



CLRCMOS1 используется для удаления данных CMOS. Чтобы сбросить и обнулить параметры системы на настройки по умолчанию, выключите компьютер и извлеките отключите кабель питания от источника питания. Подождите 15 секунд и перемычкой замкните контакты 2 и 3 на CLRCMOS1 на 5 секунд. Не сбрасывайте настройки CMOS сразу после обновления BIOS. При необходимости сбросить настройки CMOS сразу после обновления BIOS сначала перезагрузите систему, а затем выключите компьютер перед сбросом настроек CMOS. Учтите, что пароль, дата, время и профиль пользователя по умолчанию сбрасываются только в том случае, если извлечь батарею CMOS.

## 1.4 Колодки и разъемы, расположенные на материнской плате



Расположенные на материнской плате колодки и разъемы перемычками НЕ являются. НЕ устанавливайте на эти колодки и разъемы колпачковые перемычки. Установка колпачковых перемычек на эти колодки и разъемы может вызвать неустраняемое повреждение материнской платы.

Колодка системной панели  
(9-контактная, PANEL1)  
(См. стр. 1, № 16)

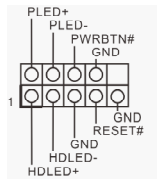

Подключите расположенные на корпусе выключатель питания, кнопку перезагрузки и индикатор состояния системы к этой колодке в соответствии с распределением контактов, приведенным ниже. Перед подключением кабелей определите положительный и отрицательный контакты.



**PWRBTN (кнопка питания):**

Подключение кнопки питания, расположенной на передней панели корпуса. Можно настроить порядок выключения системы с использованием кнопки питания.

**RESET (кнопка перезагрузки):**

Подключение кнопки перезагрузки системы, расположенной на передней панели корпуса. Нажмите кнопку перезагрузки, чтобы перезапустить компьютер, если он завис и нормальный запуск невозможен.

**PLED (светодиодный индикатор питания системы):**

Подключение индикатора состояния, расположенного на передней панели корпуса. Светодиодный индикатор горит, когда система работает. Когда система находится в режиме ожидания S1/S3, светодиод мигает. Когда система находится в режиме ожидания S4 или выключена (S5), светодиод не горит.

**HDLED (светодиодный индикатор работы жесткого диска):**

Подключение светодиодного индикатора работы жесткого диска, расположенного на передней панели корпуса. Светодиодный индикатор горит, когда жесткий диск выполняет считывание или запись данных.

Передняя панель может быть разной на разных корпусах. В основном передняя панель включает в себя кнопку питания, кнопку перезагрузки, светодиодный индикатор питания, светодиодный индикатор работы жесткого диска, динамик и т. д. При подключении передней панели к этой колодке правильно подключайте провода к контактам.

Колодка светодиодного индикатора питания (3-контактная, PLED1) (См. стр. 1, № 14)



Подключите светодиодный индикатор питания корпуса к этой колодке, чтобы обеспечить индикацию состояния питания системы.

Разъемы Serial ATA2 (SATA2\_4: (См. стр. 1, № 13) (SATA2\_5: (См. стр. 1, № 12)



Эти два разъема SATA2 предназначены для подключения кабелей SATA внутренних запоминающих устройств для передачи данных со скоростью до 3,0 Гб/с.

Разъемы Serial ATA3 (SATA3\_0: см. стр.1, № 9) (SATA3\_1: (См. стр. 1, № 10) (SATA3\_2: (См. стр. 1, № 8) (SATA3\_3: см. стр.1, № 11)

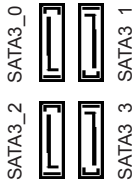

Эти четыре разъема SATA3 предназначены для подключения кабелей SATA внутренних запоминающих устройств для передачи данных со скоростью до 6,0 Гб/с.

Колодки USB 2.0. (9-контактная, USB4\_5) (См. стр. 1, № 20) (9-контактная, USB6\_7) (См. стр. 1, № 19)

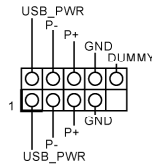

Кроме четыре портов USB 2.0 на панели ввода-вывода на материнской плате также есть две колодки. Каждая колодка USB 2.0 может поддерживать два порта.

Колодка USB 3.0 (19-контактная, USB3\_2\_3) (См. стр. 1, № 7)

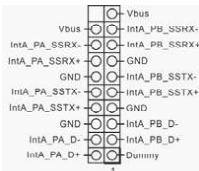

Кроме два портов USB 3.0 на панели ввода-вывода на материнской плате также есть одна колодка. Каждая колодка USB 3.0 может поддерживать два порта.



### Аудиоколодка передней панели

(9-контактная, HD\_AUDIO1)  
(См. стр. 1, № 23)

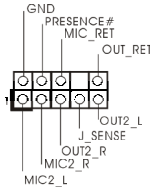

Эта колодка предназначена для подключения аудиоустройств к передней аудиопанели.



1. Аудиосистема высокого разрешения поддерживает функцию распознавания разъема, но для ее правильной работы необходимо, чтобы провод панели корпуса поддерживал передачу сигналов HDA. Инструкции по установке системы см. в этом руководстве и руководстве на корпус.
2. При использовании аудиопанели AC'97 подключите ее к аудиоколодке передней панели, как указано далее:
  - A. Подключите Mic\_IN (MIC) к MIC2\_L.
  - B. Подключите Audio\_R (RIN) к OUT2\_R, Audio\_L (LIN) к OUT2\_L.
  - C. Подключите провод заземления (GND) к контакту заземления (GND).
  - D. Контакты MIC\_RET и OUT\_RET используются только для аудиопанели высокого разрешения. При использовании аудиопанели AC'97 их подключать не нужно.
  - E. Чтобы активировать передний микрофон, перейдите на вкладку FrontMic панели управления Realtek и отрегулируйте параметр Recording Volume (Громкость записи).

### Колодка динамика корпуса

(4-контактная, SPEAKER1)  
(См. стр. 1, № 15)

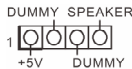

Предназначена для подключения динамика корпуса.

### Выходной разъем SPDIF

(2-контактный, SPDIF\_OUT1)  
(См. стр. 1, № 24)



Подключите разъем SPDIF\_OUT карты HDMI VGA к этой колодке при помощи кабеля.

### Разъемы для вентиляторов корпуса и блока питания

(4-контактный, CHA\_FAN1)  
(См. стр. 1, № 18)

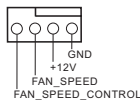

Предназначены для подключения кабелей разъемов вентиляторов и подключения черного провода к заземлению.

(4-контактный, CHA\_FAN2)  
(См. стр. 1, № 17)



(3-контактный, PWR\_  
FAN1)

(См. стр. 1, № 2)

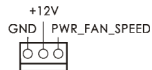

Разъемы вентиляторов  
ЦП

(4-контактный, CPU\_  
FAN1)

(См. стр. 1, № 3)

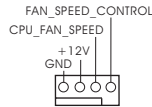

(3-контактный, CPU\_  
FAN2)

(См. стр. 1, № 1)



Эта материнская  
плата снабжена  
4-контактным разъемом  
для маломощного  
вентилятора ЦП.  
Если вы собираетесь  
подключить  
3-контактный  
вентилятор процессора,  
подключайте его к  
контактам 1-3.

Разъем питания ATX  
(24-контактный,  
ATXPWR1)

(См. стр. 1, № 6)

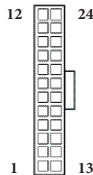

Эта материнская  
плата снабжена  
24-контактным  
разъемом питания ATX.  
Чтобы использовать  
20-контактный  
разъем питания ATX,  
подключите его вдоль  
контакта 1 и контакта  
13.

Разъем питания ATX 12 В  
(8-контактный,  
ATX12V1)

(См. стр. 1, № 4)

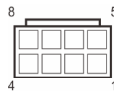

Эта материнская  
плата снабжена  
8-контактным разъемом  
питания ATX 12 В.  
Чтобы использовать  
4-контактный  
разъем питания ATX,  
подключите его вдоль  
контакта 1 и контакта 5.

Колodka инфракрасного  
модуля

(5-контактная, IR1)

(См. стр. 1, № 22)

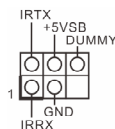

Эта колodka поддерживает  
дополнительную  
беспроводную передачу  
и прием сигналов  
инфракрасного модуля.

Колодка TPM  
(17-контактная, TPMS1)  
(См. стр. 1, № 21)

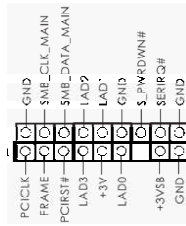

Этот разъем обеспечивает поддержку системы Trusted Platform Module (TPM), которая способна обеспечить надежное хранение ключей, цифровых сертификатов, паролей и данных. Система TPM также повышает уровень сетевой безопасности, защищает цифровые идентификаторы и обеспечивает целостность платформы.

# 1 Introdução

Obrigado por ter comprado a placa principal ASRock P85 Pro3, uma placa principal fiável produzida sob os rigorosos critérios de controlo de qualidade da ASRock. Esta placa principal oferece um excelente desempenho com um design robusto em conformidade com o compromisso da ASRock em fabricar produtos de qualidade e resistentes.



*Dado que as especificações da placa principal e o software do BIOS poderão ser actualizados, o conteúdo desta documentação estará sujeito a alterações sem aviso prévio. Caso ocorram modificações a esta documentação, a versão actualizada estará disponível no Web site da ASRock sem aviso prévio. Se necessitar de assistência técnica relacionada com esta placa principal, visite o nosso Web site para obter informações específicas acerca do modelo que está a utilizar. Também poderá encontrar a lista de placas VGA e CPU mais recentes suportadas no Web site da ASRock. Web site da ASRock <http://www.asrock.com>.*

## 1.1 Conteúdo da embalagem

- Placa principal ASRock P85 Pro3 (Formato ATX)
- Guia de instalação rápida do ASRock P85 Pro3
- CD de suporte do ASRock P85 Pro3
- 2 x Cabos de dados Serial ATA (SATA) (Opcional)
- 1 x Painel de E/S

## 1.2 Especificações

### Plataforma

- Formato ATX
- Design de condensador sólido

### CPU

- Suporta processadores Intel® Core™ i7 / i5 / i3 / Xeon® / Pentium® / Celeron® de 4ª geração em socket LGA1150
- Design Digi Power
- Design com 4 fases de alimentação
- Suporta a tecnologia Intel® Turbo Boost 2.0

### Chipset

- Intel® B85
- Suporta a tecnologia Intel® Small Business Advantage 2.0

### Memória

- Tecnologia de memória DDR3 de dois canais
- 2 x ranhuras DIMM DDR3
- Suporta memória DDR3 1600/1333/1066, não ECC, sem memória intermédia
- Capacidade máxima da memória do sistema: 16GB (consultar AVISO)
- Suporta Extreme Memory Profile (XMP)1.3/1.2 da Intel®

### Ranhuras de expansão

- 1 x ranhura PCI Express 3.0 x16
- 2 x ranhura PCI Express 2.0 x1
- 3 x ranhuras PCI

### Áudio

- Áudio HD de 5.1 canais (Codec de áudio Realtek ALC662)
- TI® NE5532 (suporta amplificador de auscultadores premium até 600 Ohms)

### LAN

- LAN Gigabit 10/100/1000 Mb/s PCIE x1
- Realtek RTL8111G
- Suporta Wake-On-LAN
- Suporta Detecção de cabo LAN
- Suporta IEEE 802.3az
- Suporta PXE

**E/S do painel traseiro**

- 1 x Porta PS/2 para mouse
- 1 x Porta PS/2 para teclado
- 1 x Porta COM1
- 1 x Porta paralela (com suporte ECP/EPP)
- 1 x Porta de Saída SPDIF Coaxial
- 4 x portas USB 2.0
- 2 x portas USB 3.0
- 1 x Porta LAN RJ-45 com LED (LED ACT/LIGAÇÃO e LED DE VELOCIDADE)
- Entrada de linha / Altifalante frontal / Microfone

**Armazenamento**

- 4 x conectores SATA3 a 6,0 Gb/s, com suporte para NCQ, AHCI e funções “Hot Plug”
- 2 x conectores SATA2 a 3,0 Gb/s, com suporte para NCQ, AHCI e funções “Hot Plug”

**Conector**

- 1 x Terminal IR
- 1 x Conector para LED de alimentação
- 1 x Terminal TPM
- 2 x Conectores da ventoinha da CPU (1 x 4 pinos, 1 x 3 pinos)
- 2 x Conectores da ventoinha do chassis (1 x 4 pinos, 1 x 3 pinos)
- 1 x Conector da ventoinha de alimentação (3 pinos)
- 1 x conector de alimentação de 24 pinos ATX
- 1 x conector de alimentação de 12V de 8 pinos
- 1 x conector de áudio do painel frontal
- 1 x Conector de saída SPDIF
- 2 x terminais USB 2.0 (suporte para 4 portas USB 2.0)
- 1 x terminal USB 3.0 (suporte para 2 portas USB 3.0)

**Funcionalidades da BIOS**

- BIOS UEFI oficial da AMI com 64Mb com suporte de interface multilíngue
- Eventos de reactivação compatíveis com ACPI 1.1
- Suporta SMBIOS 2.3.1
- Multi-ajuste de tensão de CPU, DRAM, PCH 1,05V

**CD de suporte**

- Controladores, Utilitários, Software antivírus (versão de avaliação), CyberLink MediaEspresso 6.5 - Versão de avaliação, Navegador e Barra de Ferramentas Google Chrome, Start8

### Monitor de Hardware

- Sensor de temperatura de CPU/Chassis/Alimentação
- Taquímetro de ventoinha de CPU/Chassis/Alimentação
- Ventoinha de CPU/Chassis silenciosa (Permite o ajuste automático da velocidade da ventoinha do chassis através da temperatura da CPU)
- Controlo de velocidade da ventoinha de CPU/Chassis
- Monitorização da tensão: +12V, +5V, +3,3V, CPU Vcore

### Sistema Operativo

- Compatível com Microsoft® Windows® 8 / 8 64-bits / 7 / 7 64-bits

### Certificações

- FCC, CE, WHQL
- Preparada para ErP/EuP (é necessária uma fonte de alimentação preparada para ErP/EuP)

\* Para obter informações detalhadas acerca do produto, visite o nosso Web site: <http://www.asrock.com>



Tenha em atenção que o overlocking inclui um determinado grau de risco, incluindo o ajuste das definições na BIOS, a aplicação de tecnologia Untied Overlocking ou a utilização de ferramentas de overlocking de terceiros. O overlocking poderá afectar a estabilidade do sistema, ou mesmo causar danos aos componentes e dispositivos do seu sistema. Overlocking deverá ser efectuado por sua conta e risco. Não nos responsabilizamos por possíveis danos causados pelo overlocking.



Devido às limitações, o tamanho real da memória de 4GB reservada para utilização em sistemas operativos Windows® 32-bits poderá ser inferior. Os sistemas operativos Windows® 64-bits não possuem essas limitações. Pode utilizar o ASRock XFast RAM para dar uso à memória que o Windows® não utiliza.

## 1.3 Configuração dos jumpers

A imagem abaixo ilustra como os jumpers são configurados. Quando a tampa do jumper é colocada nos pinos, o jumper é "Curto". Se não for colocada uma tampa de jumper nos pinos, o jumper é "Aberto". A imagem ilustra um jumper de 3 pinos cujos pino1 e pino2 estão "Curtos" quando a tampa do jumper é colocada nestes 2 pinos.

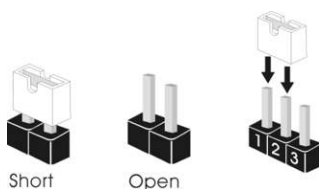

Jumper para limpar o CMOS  
(CLRCMOS1)  
(consultar p.1, N.º 25)



CLRCMOS1 permite-lhe limpar os dados no CMOS. Para limpar e repor os parâmetros do sistema para os valores predefinidos, encerre o computador e desligue a ficha da tomada. Depois de aguardar 15 segundos, utilize uma tampa de jumper para ligar o pino2 e o pino3 no CLRCMOS1 durante 5 segundos. No entanto, não limpe o CMOS logo após ter efectuado a actualização da BIOS. Se precisar de limpar o CMOS logo após ter terminado uma actualização da BIOS, deverá primeiro iniciar o sistema e voltar a encerrá-lo antes de efectuar a acção de limpeza do CMOS. Tenha em atenção que a palavra-passe, data, hora e perfil predefinido de utilizador apenas serão limpos se a pilha do CMOS for retirada.



## 1.4 Terminais e conectores integrados



Os terminais e conectores integrados **NÃO** são jumpers. **NÃO** coloque tampas de jumpers sobre estes terminais e conectores. Colocar tampas de jumpers sobre os terminais e conectores irá causar danos permanentes à placa principal.

Terminal do painel de sistema  
(PAINEL1 de 9 pinos)  
(consultar p.1, N.º 16)

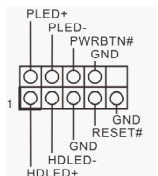

Ligue o botão de alimentação, o botão de reposição e o indicador do estado do sistema no chassis a este terminal de acordo com a descrição abaixo. Tenha em atenção os pinos positivos e negativos antes de ligar os cabos.



**PWRBTN (Botão de alimentação):**

Ligue ao botão de alimentação no painel frontal do chassis. Pode configurar a forma para desligar o seu sistema através do botão de alimentação.

**RESET (Botão de reposição):**

Ligue ao botão de reposição no painel frontal do chassis. Prima o botão de reposição para reiniciar o computador caso este bloqueie e não seja possível reiniciar normalmente.

**PLED (LED de alimentação do sistema):**

Ligue ao indicador do estado da alimentação no painel frontal do chassis. O LED ficará aceso quando o sistema estiver em funcionamento. O LED ficará intermitente quando o sistema estiver nos estados de suspensão S1/S3. O LED ficará desligado quando o sistema estiver no estado de suspensão S4 ou desligado (S5).

**HDLED (LED de actividade do disco rígido):**

Ligue ao LED de actividade do disco rígido no painel frontal do chassis. O LED ficará aceso quando o disco rígido estiver a ler ou a escrever dados.

O design do painel frontal poderá variar dependendo do chassis. Um módulo de painel frontal consiste principalmente em um botão de alimentação, um botão de reposição, um LED de alimentação, um LED de actividade do disco rígido, um altifalante, etc. Ao ligar o seu módulo de painel frontal do chassis a este conector, certifique-se de que os fios e os pinos têm uma correspondência exacta.

Conector do LED de alimentação  
(PLED1 de 3 pinos)  
(consultar p.1, N.º 14)



Ligue o LED de alimentação do chassis a este terminal para indicar o estado de alimentação do sistema.

Conectores ATA2 de série  
(SATA2\_4:  
consultar p.1, N.º 13)  
(SATA2\_5:  
consultar p.1, N.º 12)

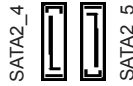

Estes dois conectores SATA2 suportam cabos de dados SATA para dispositivos de armazenamento interno com uma velocidade de transferência de dados de até 3,0 Gb/s.

Conectores ATA3 de série  
(SATA3\_0:  
consultar p.1, N.º 9)  
(SATA3\_1:  
consultar p.1, N.º 10)  
(SATA3\_2:  
consultar p.1, N.º 8)  
(SATA3\_3:  
consultar p.1, N.º 11)

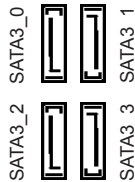

Estes quatro conectores SATA3 suportam cabos de dados SATA para dispositivos de armazenamento interno com uma velocidade de transferência de dados de até 6,0 Gb/s.

Terminais USB 2.0  
(USB4\_5 de 9 pinos)  
(consultar p.1, N.º 20)  
(USB6\_7 de 9 pinos)  
(consultar p.1, N.º 19)

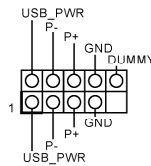

Para além das quatro portas USB 2.0 no painel de E/S, existem dois terminais nesta placa principal. Cada terminal USB 2.0 é capaz de suportar duas portas.

Terminal USB 3.0  
(USB3\_2\_3 de 19 pinos)  
(consultar p.1, N.º 7)

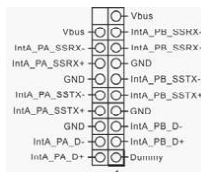

Para além das duas portas USB 3.0 no painel de E/S, existe um terminal nesta placa principal. Cada terminal USB 3.0 é capaz de suportar duas portas.

Terminal de áudio do  
painel frontal  
(HD\_AUDIO1 de 9 pinos)  
(consultar p.1, N.º 23)

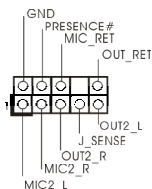

Este terminal destina-se  
à ligação de dispositivos  
áudio ao painel de áudio  
frontal.



1. O Áudio de alta definição suporta Detecção de ficha, mas o cabo de painel no chassis deverá suportar HDA para funcionar correctamente. Siga as instruções no nosso manual e no manual do chassis para instalar o seu sistema.
2. Se utilizar um painel de áudio AC'97, instale-o no terminal de áudio do painel frontal de acordo com os passos abaixo:
  - A. Ligue Mic\_IN (MIC) a MIC2\_L.
  - B. Ligue Audio\_R (RIN) a OUT2\_R e Audio\_L (LIN) a OUT2\_L.
  - C. Ligue Terra (GND) a Terra (GND).
  - D. MIC\_RET e OUT\_RET destinam-se apenas ao painel de áudio HD. Não precisa de os ligar para o painel de áudio AC'97.
  - E. Para activar o microfone frontal, aceda ao separador "Microfone Frontal" no painel de controlo Realtek e ajuste o "Volume de gravação".

Terminal do altifalante  
do chassis  
(SPEAKER1 de 4 pinos)  
(consultar p.1, N.º 15)



Ligue o altifalante do  
chassis a este terminal.

Conector de saída SPDIF  
(SPDIF\_OUT1 de 2 pinos)  
(consultar p.1, N.º 24)



Ligue o conector SPDIF\_  
OUT da placa VGA  
HDMI a este terminal  
através de um cabo.

Conectores da ventoinha  
do chassis e alimentação  
(CHA\_FAN1 de 4 pinos)  
(consultar p.1, N.º 18)

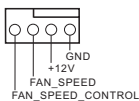

Ligue os cabos da  
ventoinha aos conectores  
da ventoinha colocando  
o cabo preto no pino de  
ligação à terra.

(CHA\_FAN2 4 pinos)  
(consultar p.1, N.º 17)



(PWR\_FAN1 de 3 pinos)  
(consultar p.1, N.º 2)



Conectores da ventoinha da CPU  
(CPU\_FAN1 de 4 pinos)  
(consultar p.1, N.º 3)

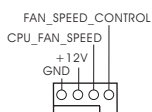

(CPU\_FAN2 de 3 pinos)  
(consultar p.1, N.º 1)



Esta placa principal inclui um conector de ventoinha de CPU (Ventoinha silenciosa) de 4 pinos.

Se pretender ligar uma ventoinha de CPU de 3 pinos, ligue-a ao Pino 1-3.

Conector de alimentação ATX  
(ATXPWR1 de 24 pinos)  
(consultar p.1, N.º 6)

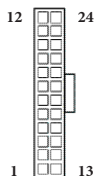

Esta placa principal inclui um conector de alimentação de 12V ATX de 24 pinos. Para utilizar uma fonte de alimentação ATX de 20 pinos, introduza-a no Pino 1 o Pino 13.

Conector de alimentação de 12V ATX  
(ATX12V1 de 8 pinos)  
(consultar p.1, N.º 4)

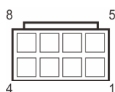

Esta placa principal inclui um conector de alimentação de 12V ATX de 8 pinos. Para utilizar uma fonte de alimentação ATX de 4 pinos, introduza-a no Pino 1 o Pino 5.

Terminal do módulo de infra-vermelhos  
(IR1 de 5 pinos)  
(consultar p.1, N.º 22)

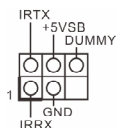

Este terminal suporta um módulo de infra-vermelhos opcional para transmissão e recepção sem fios.

Terminal TPM  
(TPMS1 de 17 pinos)  
(consultar p.1, N.º 21)

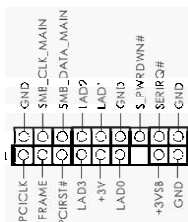

Este conector suporta um sistema com Módulo de Plataforma Confiável (TPM), que pode armazenar com segurança chaves, certificados digitais, palavras-passe e dados. Um sistema TPM também ajuda a melhorar a segurança de rede, a proteger identidades digitais e a garantir a integridade da plataforma.

# 1 Giriş

ASRock'ın zorlu kalite kontrol süreçlerinden geçmiş olan ASRock P85 Pro3 anakartını satın aldığınız için teşekkür ederiz. Sağlam tasarımı ile ASRock'ın kalite ve dayanıklılık taahhüdüne uygun şekilde mükemmel performans sağlar.



*Anakart özellikleri ve BIOS yazılımı güncellenebileceğinden, bu dokümantasyonun içeriği herhangi bir bildirimde bulunulmaksızın değiştirilebilir. Bu dokümantasyon üzerinde herhangi bir değişiklik yapılması halinde, güncellenmiş sürüm, herhangi bir bildirim yapılmaksızın ASRock'ın web sitesinde yer alacaktır. Bu anakart ile ilgili olarak teknik destek almak istiyorsanız, lütfen kullandığımız model hakkında özel bilgiler için web sitemizi ziyaret edin. En güncel VGA kartları ve CPU destek listelerini de ASRock'ın web sitesinden bulabilirsiniz. ASRock'ın web sitesi <http://www.asrock.com>.*

## 1.1 Ambalaj İçeriği

- ASRock P85 Pro3 Anakartı (ATX Form Faktörü)
- ASRock P85 Pro3 Hızlı Kurulum Kılavuzu
- ASRock P85 Pro3 Destek CD'si
- 2 x Seri ATA (SATA) Veri Kablosu (İsteğe Bağlı)
- 1 x I/O Panel Kalkanı

## 1.2 Özellikler

### Platform

- ATX Form Faktörü
- Tam Katı Bağlayıcı tasarımı

### CPU

- 4ncü Nesil Intel® Core™ i7 / i5 / i3 / Xeon® / Pentium® / Celeron®, LGA1150 Paketinde desteklemektedir
- Dijital Güç Tasarımı
- 4 Güç Safhası Tasarımı
- Intel® Turbo Boost 2.0 Teknolojisini destekler

### Yonga kümesi

- Intel® B85
- Intel® Küçük İşletme Avantaj 2.0 özelliğini destekler

### Bellek

- Çift Kanallı DDR3 Bellek Teknolojisi
- 2 x DDR3 DIMM yuvaları
- DDR3 1600/1333/1066 ECC olmayan, ara belleğe alınmamış belleği destekler
- Maksimum sistem belleği kapasitesi: 16GB (bkz. DİKKAT ikazı)
- Intel® Üstün Bellek Profili (XMP)1.3/1.2 özelliğini destekler

### Genişletme

- 1 x PCI Express 3.0 x16 yuva

### Yuvası

- 2 x PCI Express 2,0 x1 yuva
- 3 x PCI yuvası

### Ses

- 5.1 CH HD Ses (Realtek ALC662 Ses Codec Bileşeni)
- TI® NE5532 (600 Ohm'a kadar Premium Kulaklık Yükselticisi desteği)

### LAN

- PCIE x1 Gigabit LAN 10/100/1000 Mb/s
- Realtek RTL8111G
- LAN Açılışını Destekler
- LAN Kablo Algılama'yı destekler
- Enerji Verimliliğine Sahip Ethernet 802.3az işlevini destekler
- PXE özelliğini destekler

## Arka Panel I/O

- 1 x PS/2 Fare Bağlantı Noktası
- 1 x PS/2 Klavye Bağlantı Noktası
- 1 x Seri Port: COM1
- 1 x Paralel Portu (ECP/EPP destekler)
- 1 x Koaksiyel SPDIF Çıkışı Portu
- 4 x USB 2.0 Bağlantı noktası
- 2 x USB 3.0 Bağlantı noktası
- LED'e sahip 1 x RJ-45 LAN Bağlantı Noktası (ACT/LINK LED ve SPEED LED)
- HD Ses Jakı: Hat Girişi / Ön Hoparlör / Mikrofon

## Depolama

- 4 x SATA3 6,0 Gb/s bağlayıcıları NCQ, AHCI ve “Hot Plug” işlevlerini destekler
- 2 x SATA2 3,0 Gb/s bağlayıcıları NCQ, AHCI ve “Hot Plug” işlevlerini destekler

## Bağlayıcı

- 1 x IR bağlantısı
- 1 x Güç LED bağlantısı
- 1 x TPM bağlantısı
- 2 x CPU Fan bağlayıcıları (1 x 4-pin, 1 x 3-pin)
- 2 x Kasa Fanı bağlayıcıları (1 x 4-pin, 1 x 3-pin)
- 1 x Güç Fanı bağlayıcısı (3-pin)
- 1 x 24 pin ATX güç bağlayıcısı
- 1 x 8 pin 12V güç bağlayıcısı
- 1 x Ön panel ses bağlayıcısı
- 1 x SPDIF Çıkış bağlayıcısı
- 2 x USB 2.0 bağlantısı (4 USB 2.0 bağlantı noktasını destekler)
- 1 x USB 3.0 bağlantısı (2 USB 3.0 bağlantı noktasını destekler)

## BIOS Özelliği

- Çok dilli GUI Desteği ile 64Mb AMI UEFI Legal BIOS
- ACPI 1.1 Uyumluluğu Uyandırma Olayları
- SMBIOS 2.3.1 Desteği
- CPU, DRAM, PCH 1,05V Voltaj Çoklu Ayarı

## Destek CD'si

- Sürücüler, Yardımcı Yazılımlar, AntiVirüs Yazılımı (Deneme Sürümü), CyberLink MediaEspresso 6.5 Deneme Sürümü, Google Chrome Tarayıcı ve Araç Çubuğu, Start8



### Donanım Monitörü

- CPU/Kasa/Güç Sıcaklığı Tespiti
- CPU/Kasa/Güç Fanı Devirölçer
- CPU/Kasa Sessiz Fan (Kasa Fan Hızının CPU Sıcaklığına Göre Otomatik olarak Ayarlanmasını Sağlar)
- CPU/Kasa Fanı Çoklu Hız Kontrolü
- Voltaj Denetleme: +12V, +5V, +3,3V, CPU Vcore

### OS

- Microsoft® Windows® 8 / 8 64-bit / 7 / 7 64-bit ile uyumlu

### Belgeler

- FCC, CE, WHQL
- ErP/EuP için hazır (ErP/EuP için hazır güç beslemesi gereklidir)

\* Detaylı ürün bilgisi için, lütfen web sitemizi ziyaret edin: <http://www.asrock.com>



Lütfen, BIOS ayarlarını düzenleme, Bağımsız Hız Aşırtma Teknolojinin uygulanması ya da üçüncü kişilerin hız aşırma araçlarının kullanılması da dahil olmak üzere tüm hız aşırma işlemlerinin belirli bir risk taşıdığını unutmayın. Hız aşırma, sisteminizin dayanıklılığını etkileyebilir, hatta sisteminizde yer alan bileşen ve aygıtlara zarar verebilir. Bunu riski ve masrafları size ait olmak üzere gerçekleştirilmelidir. Hız aşırıtmadan doğabilecek zararlar konusunda sorumlu olmayacağız.



Sınırlamalar nedeniyle, gerçek bellek boyutu Windows® 32-bit işletim sistemleri çerçevesinde sistem kullanımına ayrıldığı için 4GB'den az olabilir. Windows® 64-bit işletim sistemlerinde bu tür sınırlamalar yoktur. Windows® tarafından kullanılmayan bellekten faydalanmak için ASRock XFast RAM'i kullanabilirsiniz.

### 1.3 Bağlantı Teli Kurulumu

Çizim, bağlantı tellerinin kurulumunu göstermektedir. Tel kapağı, pimlerin üzerine yerleştirildiğinde, tel "Kısa" olur. Pimlerin üzerinde tel kapağı bulunmadığında, tel "Kısa" olur. Çizim, pin1 ve pin2 alanları "Kısa" olan ve bu iki pim üzerinde bir bağlantı teli kapağı bulunan 3-pin bağlantı telini göstermektedir.

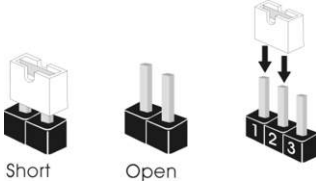

CMOS'u Temizle Bağlantı  
Teli  
(CLRCMOS1)  
(bkz. sf.1, No. 25)



Varsayılan



CMOS'u Temizle

CLRCMOS1, CMOS verilerini temizlememizi sağlar. Sistem parametrelerini temizlemek ve varsayılan kurulum ayarlarına sıfırlamak için, lütfen bilgisayarı kapatın ve güç kablosunu güç beslemesinden çekin. 15 saniye bekledikten sonra, CLRCMOS1 üzerindeki pin2 ve pin3'ü 5 saniye boyunca kısaltmak için bir bağlantı teli kullanın. Ancak, CMOS'u lütfen BIOS'u güncelledikten hemen sonra temizlemeyin. BIOS'u güncelledikten hemen sonra CMOS'u temizlemeniz gerekirse, önce sistemi başlatın ve ardından CMOS temizleme işlemi öncesinde yeniden kapatın. Lütfen, parola, tarih, saat ve varsayılan kullanıcı profilinin yalnızca CMOS bataryası çıkarıldığında temizleneceğini unutmayın.

## 1.4 Ekli Bağlantılar ve Bağlayıcılar



*Ekli bağlantılar ve bağlayıcılar bağlantı teli değildir. Bağlantı teli kapaklarını bu bağlantı ve bağlayıcılar üzerine yerleştirmeyin. Bağlantı teli kapaklarını bağlantılar ile bağlayıcılar üzerine yerleştirilmesi, anakarta kalıcı hasar verebilir.*

**Sistem Paneli Bağlantısı**  
(9-pin PANEL1)  
(bkz sf.1, No. 16)

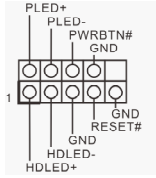

Güç anahtarını bağlayın, kasa üzerindeki anahtar ile sistem durumu belirtecini aşağıdaki pim düzenine göre sıfırlayın. Kabloları bağlarken pozitif ve negatif pimleri not edin.



**PWRBTN (Güç Anahtarı):**

Güç anahtarını kasa ön paneline bağlayın. Güç anahtarını kullanarak sistemin hangi yöne hareketle kapanacağını seçebilirsiniz.

**RESET (Sıfırlama Anahtarı):**

Sıfırlama anahtarını kasa ön paneline bağlayın. Bilgisayarın kilitlemesi ve normal şekilde yeniden başlatılmaması halinde reset (sıfırla) düğmesine basın.

**PLED (Sistem Gücü LED):**

Güç durumu belirtecini kasa ön paneline bağlayın. Sistem çalışırken LED ışığı yanacaktır. Sistem S1/S3 uyku durumdayken LED ışığı yanıp söner. Sistem S4 uyku durumunda ya da kapalıyken (S5) LED ışık kapanır.

**HDLED (Sabit Disk Aktivitesi LED):**

Sabit Disk Aktivitesi LED'i kasanın ön paneline bağlayın. Sabit sürücü veri okur ya da yazarken LED ışığı yanar.

Ön panel tasarımı kasaya göre değişiklik gösterebilir. Bir ön panel modülü, temel olarak bir güç anahtarı, sıfırlama anahtarı, güç LED'i, sabit sürücü aktivitesi LED'i, hoparlör gibi birimlerden oluşur. Kasanızın ön panel modülünü bu bağlantıya takmadan önce, kablo düzenlemeleri ile pin düzenlemelerinin düzgün şekilde yapıldığından emin olun.

Güç LED Bağlantısı  
(3-pin PLED1)  
(bkz. sf.1, No. 14)



Sistemin güç durumunun belirtilmesi için lütfen güç LED'ini bu bağlantıya takın.

Seri ATA2 Bağlayıcıları  
(SATA2\_4:  
bkz. sf.1, No. 13)  
(SATA2\_5:  
bkz. sf.1, No. 12)



Bu iki SATA2 bağlayıcısı, veri aktarım hızı 3,0 Gb/sn'ye kadar olan dahili depolama aygıtları için tasarlanmış SATA veri kablolarını destekler.

Seri ATA3 Bağlayıcıları  
(SATA3\_0:  
bkz. sf.1, No. 9)  
(SATA3\_1:  
bkz. sf.1, No. 10)  
(SATA3\_2:  
bkz. sf.1, No. 8)  
(SATA3\_3:  
bkz. sf.1, No. 11)

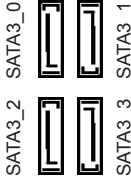

Bu dört SATA3 bağlayıcısı, veri aktarım hızı 6,0 Gb/sn'ye kadar olan dahili depolama aygıtları için tasarlanmış SATA veri kablolarını destekler.

USB 2.0 Bağlantıları  
(9-pin USB4\_5)  
(bkz. sf.1, No. 20)  
(9-pin USB6\_7)  
(bkz. sf.1, No. 19)

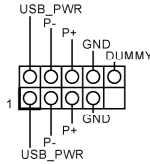

Bu anakart üzerinde, I/O paneli üzerindeki dört USB 2.0 bağlantı noktasının yanı sıra, iki adet bağlantı bulunmaktadır. Her USB 2.0 bağlantısı, iki adet bağlantı noktasını destekleyebilir.

USB 3.0 Bağlantı  
(19-pin USB3\_2\_3)  
(bkz. sf.1, No. 7)

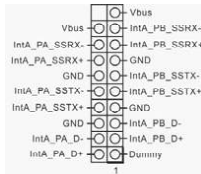

Bu anakart üzerinde, I/O paneli üzerindeki iki USB 3.0 bağlantı noktasının yanı sıra, bir adet bağlantı bulunmaktadır. Her USB 3.0 bağlantısı, iki adet bağlantı noktasını destekleyebilir.

**Ön Panel Ses Bağlantısı**  
(9-pin HD\_AUDIO1)  
(bkz. sf.1, No. 23)

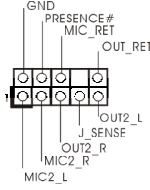

Bu bağlantı, ses aygıtlarının ön ses paneline bağlanması içindir.



1. Yüksek Tanımlı Ses, Jak Algılama özelliğini destekler, ancak bu işlevin düzgün çalışabilmesi için kasa üzerindeki panel kablosunun HDA işlevini desteklemesi gerekmektedir. Sisteminizi kurarken, lütfen kılavuzumuzdaki talimatlar ile kasa kılavuzundaki talimatları izleyin.
2. Bir AC'97 ses paneli kullanıyorsanız, lütfen bu paneli aşağıdaki adımları izleyerek ön panel ses bağlantısına takın:
  - A. Mic\_IN (MIC)'i MIC2\_L'ye bağlayın.
  - B. Audio\_R (RIN)'i OUT2\_R'ye ve Audio\_L (LIN)'yi OUT2\_L'ye bağlayın.
  - C. Topraklamayı (GND) Topraklamaya (GND) bağlayın.
  - D. MIC\_RET ve OUT\_RET, yalnızca HD ses paneli içindir. Bunları AC'97 ses panelinden bağlamanıza gerek yoktur.
  - E. Ön mikrofonu etkinleştirmek için Realtek Denetim panelinde yer alan "FrontMic (Ön Mikrofon)" Sekmesine tıklayın ve "Recording Volume (Kayıt Sesi Düzeyi)" değerini ayarlayın.

**Kasa Hoparlör Bağlantısı**  
(4-pin SPEAKER1)  
(bkz sf.1, No. 15)

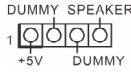

Lütfen kasa hoparlörünü bu bağlantıya takın.

**SPDIF Çıkış Bağlayıcısı**  
(2-pin SPDIF\_OUT1)  
(bkz sf.1, No. 24)



Lütfen kablo ile bu bağlantıya bir HDMI VGA kartının SPDIF\_OUT bağlayıcısı takın.

**Kasa ve Güç Fanı Bağlayıcıları**  
(4-pin CHA\_FAN1)  
(bkz sf.1, No. 18)

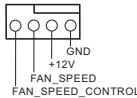

Lütfen fan kablolarını fan bağlayıcılarına takın ve siyah teli topraklama pinine bağlayın.

(4-pin CHA\_FAN2)  
(bkz sf.1, No. 17)



(3-pin PWR\_FAN1)  
(bkz sf.1, No. 2)

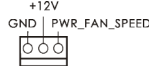

CPU Fan Bağlayıcıları  
(4-pin CPU\_FAN1)  
(bkz sf.1, No. 3)

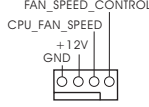

(3-pin CPU\_FAN2)  
(bkz sf.1, No. 1)



Bu anakart, 4-Pin CPU fan (Sessiz Fan) bağlayıcısı sağlamaktadır. 3-Pin CPU fan bağlamak istiyorsanız, lütfen Pin 1-3'ü kullanın.

ATX Güç Bağlayıcısı  
(24-pin ATXPWR1)  
(bkz. sf.1, No. 6)

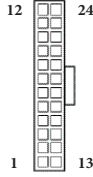

Bu anakart, 24-pin ATX güç bağlayıcısı sağlamaktadır. 20-pin ATX güç beslemesi kullanmak için, lütfen Pin 1 ve Pin13'e bağlayın.

ATX 12V Güç Bağlayıcısı  
(8-pin ATX12V1)  
(bkz. sf.1, No. 4)

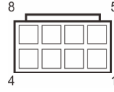

Bu anakart, 8-pin ATX 12V güç bağlayıcısı sağlamaktadır. 4-pin ATX güç beslemesi kullanmak için, lütfen Pin 1 ve Pin5'e bağlayın.

Kızılötesi Modül  
Bağlantısı  
(5-pin IR1)  
(bkz. sf.1, No. 22)

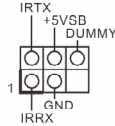

Bu bağlantı, isteğe bağlı olarak kızılötesi modülden bir kablosuz bağlantı aktarımı ile alımını da destekler.

TPM Bağlantısı  
(17-pin TPMS1)  
(bkz. sf.1, No. 21)

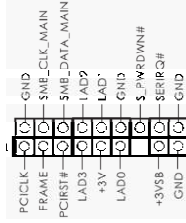

Bu bağlayıcı, anahtarlar, dijital sertifikalar, parolalar ve verileri güvenli bir şekilde saklama özelliği bulunan Güvenilir Platform Modülü (TPM) sistemini destekler. TPM sistemleri, aynı zamanda ağ güvenliğinin artırılması, dijital kimliklerin korunması ve platform bütünlüğünün sağlanmasına da yardımcıdır.

# 1 개요

ASRock P85 Pro3 마더보드를 구입해 주셔서 감사합니다. 이 마더보드는 ASRock의 일관되고 엄격한 품질관리 하에 생산되어 신뢰성이 우수합니다. 품질과 내구성에 대한 ASRock의 기준에 부합하는 우수한 성능과 견고한 설계를 제공합니다.



마더보드 규격과 BIOS 소프트웨어를 업데이트할 수도 있기 때문에, 이 문서의 내용은 예고 없이 변경될 수 있습니다. 이 설명서가 변경될 경우, 업데이트된 버전은 ASRock의 웹사이트에서 추가 통지 없이 제공됩니다. 이 마더보드와 관련하여 기술적 지원이 필요한 경우, 당사의 웹사이트를 방문하여 사용 중인 모델에 대한 구체적인 정보를 구하십시오. ASRock의 웹사이트에서는 최신 VGA 카드와 CPU 지원 목록도 찾을 수 있습니다. ASRock 웹사이트 <http://www.asrock.com>.

## 1.1 포장 내용물

- ASRock P85 Pro3 마더보드 (ATX 폼 팩터)
- ASRock P85 Pro3 간편 설치 안내서
- ASRock P85 Pro3 지원 CD
- 시리얼 ATA (SATA) 데이터 케이블 2 개 (선택 품목)
- I/O 패널 실트 1 개



## 1.2 규격

### 플랫폼

- ATX 폼 팩터
- 모든 솔리드 콘텐서 구조

### CPU

- LGA1150 패키지로 제공되는 4 세대 Intel® Core™ i7 / i5 / i3 / Xeon® / Pentium® / Celeron® 지원
- Digi 전원 구조
- 4 개 전원 위상 구조
- Intel® Turbo Boost 2.0 기술 지원

### 칩세트

- Intel® B85
- Intel® Small Business Advantage 2.0 지원

### 메모리

- 듀얼 채널 DDR3 메모리 기술
- DDR3 DIMM 슬롯 2 개
- DDR3 1600/1333/1066 비 -ECC, 비버퍼링 메모리 지원
- 시스템 메모리 최대 용량 : 16GB  
(주의 참조)
- Intel® Extreme Memory Profile (XMP)1.3/1.2 지원

### 확장 슬롯

- PCI Express 3.0 x16 슬롯 1 개
- PCI Express 2.0 x1 슬롯 2 개
- PCI 슬롯 3 개

### 오디오

- 5.1 CH HD 오디오 지원 (Realtek ALC662 오디오 코덱)
- TI® NE5532 ( 최대 600 옴의 프리미엄 헤드셋 증폭기 지원 )

### LAN

- PCIE 1 개 , Gigabit LAN 10/100/1000 Mb/s
- Realtek RTL8111G
- Wake-On-LAN 지원
- LAN 케이블 감지 지원
- 절전형 이더넷 802.3az 지원
- PXE 지원

## 후면 패널 I/O

- PS/2 마우스 포트 1 개
- PS/2 키보드 포트 1 개
- 의 COM1 1 개
- 의 병렬 포트 :ECP/EPP 지원오 디오 잭 1 개
- 동축 SPDIF 출력 포트 1 개
- USB 2 포트 4 개
- USB 3 포트 2 개
- LED 장착 RJ-45 LAN 포트 1 개 (ACT/LINK LED 및 SPEED LED)
- HD 오디오 잭 : 라인 입력 / 전면 스피커 / 마이크

## 저장 장치

- SATA3 6.0 Gb/s 커넥터 4 개 , NCQ, AHCI 및 핫 플러그 기능 지원
- SATA2 3.0 Gb/s 커넥터 2 개 , NCQ, AHCI 및 핫 플러그 기능 지원

## 커넥터

- IR 헤더 1 개
- 전원 LED 헤더 1 개
- TPM 헤더 1 개
- CPU 팬 커넥터 2 개 (1 x 4 핀 , 1 x 3 핀 )
- 새시 팬 커넥터 2 개 (1 x 4 핀 , 1 x 3 핀 )
- 전원 팬 커넥터 1 개 (3 핀 )
- 24 핀 ATX 전원 커넥터 1 개
- 8 핀 12V 전원 커넥터 1 개
- 전면 패널 오디오 커넥터 1 개
- SPDIF 출력 커넥터 1 개
- USB 2.0 헤더 2 개 (USB 2.0 포트 4 개 지원 )
- USB 3.0 헤더 1 개 (USB 3.0 포트 2 개 지원 )

## BIOS 기능

- 다국어 GUI 지원을 제공하는 64Mb AMI UEFI 적합형 BIOS
- ACPI 1.1 준수 웨이크 업 이벤트
- SMBIOS 2.3.1 지원
- CPU, DRAM, PCH 1.05V 전압 다중 조정

## 지원 CD

- 드라이버, 유틸리티, 백신 소프트웨어 ( 시험판 ), CyberLink MediaEspresso 6.5 시험판 , Google Chrome 브라우저 및 툴바 , Start8

## 하드웨어 모니터

- CPU/ 새시 / 전원 온도 감지
- CPU/ 새시 / 전원 팬 타코미터
- CPU/ 새시 저소음 팬 (CPU 온도에 의한 새시 팬 속도 자동 조정)
- CPU/ 새시 팬 다중 속도 조절
- 전압 모니터링 : +12V, +5V, +3.3V, CPU Vcore

## OS

- Microsoft® Windows® 8 / 8 64 비트 / 7 / 7 64 비트 호환

## 인증

- FCC, CE, WHQL
- ErP/EuP 사용 가능 (ErP/EuP 사용 가능 전원공급장치 필요.)

\* 자세한 제품 정보에 대해서는 당사 웹사이트를 참조하십시오 : <http://www.asrock.com>



BIOS 설정을 조정하거나 *Untied Overclocking Technology* 를 적용하거나 타업체의 오버클로킹 도구를 사용하는 것을 포함하는 오버클로킹에는 어느 정도의 위험이 따른다는 것을 유념하십시오. 오버클로킹은 시스템 안정성에 영향을 주거나 심지어 시스템의 구성 요소와 장치에 손상을 입힐 수도 있습니다. 오버클로킹은 사용자 스스로 위험과 비용을 감수하고 해야 합니다. 당사는 오버클로킹에 의해 발생할 수 있는 손상에 대해서 책임이 없습니다.



제한 때문에 실제 메모리 크기는 Windows® 32 비트 운영체제 하의 시스템 사용을 위한 예비 메모리용 4GB 보다 더 적을 수 있습니다. Windows® 64 비트 운영체제에는 그러한 제한이 없습니다. ASRock XFast RAM 을 사용하여 Windows® 가 사용할 수 없는 메모리를 이용할 수 있습니다.

### 1.3 점퍼 설정

그림은 점퍼를 어떻게 설정하는지 보여줍니다. 점퍼 캡을 핀에 끼우면 점퍼가 단락 됩니다. 점퍼 캡을 핀에 끼우지 않으면 점퍼가 단선 됩니다. 그림은 3 핀 점퍼를 보여주며 핀 1 과 핀 2 는 점퍼 캡을 끼울 때 단락 됩니다.

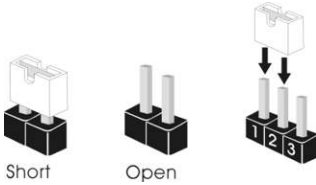

Clear CMOS 점퍼  
(CLRCMOS1)  
(1 페이지, 25 번 항목 참조)

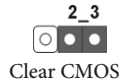

CLRCMOS1 을 사용하여 CMOS 에 저장된 데이터를 지울 수 있습니다. 시스템 파라미터를 지우고 기본 설정으로 초기화하려면 컴퓨터를 끄고 전원 코드를 전원공급장치에서 빼십시오. 15 초 동안 기다린 후 점퍼 캡을 사용하여 CLRCMOS1 의 핀 2 와 핀 3 을 5 초 동안 단락시키십시오. 그러나 BIOS 업데이트 직후에는 CMOS 를 삭제하지 마십시오. BIOS 업데이트를 완료한 직후 CMOS 를 지워야 할 경우, 우선 시스템을 부팅한 후 바이오스 업데이트를 종료한 다음 CMOS 지우기 작업을 해야 합니다. CMOS 배터리를 제거할 경우에만 암호, 날짜, 시간, 사용자 기본 프로파일이 지워집니다.

## 1.4 온보드 헤더 및 커넥터



온보드 헤더와 커넥터는 점퍼가 아닙니다. 점퍼 캡을 온보드 헤더와 커넥터에 씌우지 마십시오. 점퍼 캡을 온보드 헤더와 커넥터에 씌우면 마더보드가 영구적으로 손상됩니다.

시스템 패널 헤더  
(9 핀 PANEL1)  
(1 페이지, 16 번 항목 참조)

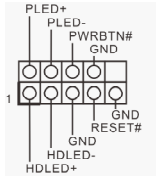

새시의 전원 스위치, 리셋 스위치, 시스템 상태 표시등을 아래의 핀 할당에 따라 이 헤더에 연결합니다. 케이블을 연결하기 전에 양극 핀과 음극 핀을 기록합니다.



**PWRBTN( 전원 스위치 ):**

새시 전면 패널의 전원 스위치에 연결합니다. 전원 스위치를 이용해 시스템을 끄는 방법을 구성할 수 있습니다.

**RESET( 리셋 스위치 ):**

새시 전면 패널의 전원 스위치에 연결합니다. 컴퓨터가 정지하고 정상작 재시작을 수행하지 못할 경우 리셋 스위치를 눌러 컴퓨터를 재시작합니다.

**PLED( 시스템 전원 LED ):**

새시 전면 패널의 전원 상태 표시등에 연결합니다. 시스템이 작동하고 있을 때는 LED 가 켜져 있습니다. 시스템이 S1/S3 대기 상태에 있을 때는 LED 가 계속 깜박입니다. 시스템이 S4 대기 상태 또는 전원 꺼짐 (S5) 상태에 있을 때는 LED 가 꺼져 있습니다.

**HDLED( 하드 드라이브 동작 LED ):**

새시 전면 패널의 하드 드라이브 동작 LED 에 연결합니다. 하드 드라이브가 데이터를 읽거나 쓰고 있을 때 LED 가 켜져 있습니다.

전면 패널 디자인은 새시별로 다를 수 있습니다. 전면 패널 모듈은 주로 전원 스위치, 리셋 스위치, 전원 LED, 하드 드라이브 동작 LED, 스피커 등으로 구성되어 있습니다. 새시 전면 패널 모듈을 이 헤더에 연결할 때 와이어 할당과 핀 할당이 정확히 일치하는지 확인합니다.

전원 LED 헤더  
(3 핀 PLED1)  
(1 페이지, 14 번 항목 참조)



시스템 전원 상태를 나타내려면 새시 전원 LED를 이 헤더에 연결하십시오.

시리얼 ATA2 커넥터  
(SATA2\_4:  
(1 페이지, 13 번 항목 참조)  
(SATA2\_5:  
(1 페이지, 12 번 항목 참조)



이들 두 개의 SATA2 커넥터는 최대 3.0 Gb/s 데이터 전송 속도를 제공하는 내부 저장 장치용 SATA 데이터 케이블을 지원합니다.

시리얼 ATA3 커넥터  
(SATA3\_0:  
1 페이지, 9 번 항목 참조)  
(SATA3\_1:  
(1 페이지, 10 번 항목 참조)  
(SATA3\_2:  
(1 페이지, 8 번 항목 참조)  
(SATA3\_3:  
1 페이지, 11 번 항목 참조)

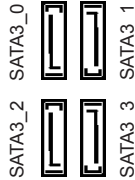

이들 4 개의 SATA3 커넥터는 최대 6.0 Gb/s 데이터 전송 속도를 제공하는 내부 저장 장치용 SATA 데이터 케이블을 지원합니다.

USB 2.0 헤더  
(9 핀 USB4\_5)  
(1 페이지, 20 번 항목 참조)  
(9 핀 USB6\_7)  
(1 페이지, 19 번 항목 참조)

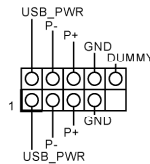

I/O 패널에 USB 2.0 포트 네 개가 탑재되어 있을 뿐 아니라 마더보드에 헤더 두 개가 탑재되어 있습니다. 각 USB 2.0 헤더는 포트 두 개를 지원할 수 있습니다.

USB 3.0 헤더  
(19 핀 USB3\_2\_3)  
(1 페이지, 7 번 항목 참조)

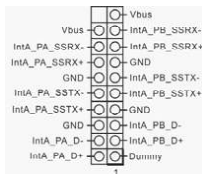

I/O 패널에 USB 3.0 포트 두 개가 탑재되어 있을 뿐 아니라 마더보드에 헤더 한 개가 탑재되어 있습니다. 각 USB 3.0 헤더는 포트 두 개를 지원할 수 있습니다.

전면 패널 오디오 헤더  
(9 핀 HD\_AUDIO1)  
(1 페이지, 23 번 항목 참조)

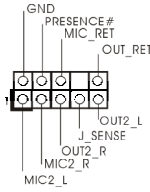

이 헤더는 오디오 장치를 전면 오디오 패널에 연결하는 데 사용됩니다.



1. 고음질 오디오는 잭 감지를 지원하지만 올바르게 작동하려면 새시의 패널 와이어가 HDA 를 지원해야 합니다. 설명서 및 새시 설명서에 나와 있는 지침을 따라 시스템을 설치하십시오.
2. AC 97 오디오 패널을 사용할 경우 아래와 같은 절차를 따라 전면 패널 오디오 헤더에 설치하십시오:
  - A. Mic\_IN (MIC) 을 MIC2\_L 에 연결합니다.
  - B. Audio\_R (RIN) 을 OUT2\_R 에 연결하고 Audio\_L (LIN) 을 OUT2\_L 에 연결합니다.
  - C. 접지 (GND) 를 접지 (GND) 에 연결합니다.
  - D. MIC\_RET 및 OUT\_RET 는 HD 오디오 패널에만 사용됩니다. AC 97 오디오 패널용으로 연결할 필요가 없습니다.
  - E. 전면 마이크를 활성화하려면 Realtek 제어판에서 FrontMic 탭으로 가서 Recording Volume( 녹음 볼륨) 을 조정합니다.

새시 스피커 헤더  
(4 핀 SPEAKER1)  
(1 페이지, 15 번 항목 참조)

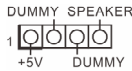

새시 스피커를 이 헤더에 연결하십시오.

SPDIF 출력 커넥터  
(2 핀 SPDIF\_OUT1)  
(1 페이지, 24 번 항목 참조)



HDMI VGA 카드의 SPDIF\_OUT 커넥터를 케이블로 이 헤더에 연결하십시오.

새시 및 전원 팬 커넥터  
(4 핀 CHA\_FAN1)  
(1 페이지, 18 번 항목 참조)

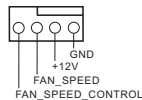

팬 케이블을 팬 커넥터에 연결하고 검은색 와이어를 접지핀에 연결하십시오.

(4 핀 CHA\_FAN2)  
(1 페이지, 17 번 항목 참조)



(3 핀 PWR\_FAN1)  
(1 페이지, 2 번 항목 참조)

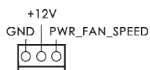

CPU 팬 커넥터  
(4 핀 CPU\_FAN1)  
(1 페이지, 3 번 항목 참조)

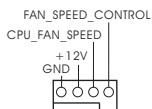

(3 핀 CPU\_FAN2)  
(1 페이지, 1 번 항목 참조)



이 마더보드에는 4 핀 CPU 팬 (저소음 팬) 커넥터가 탑재되어 있습니다. 3 핀 CPU 팬을 연결하려는 경우 핀 1-3 에 연결하십시오.

ATX 전원 커넥터  
(24 핀 ATXPWR1)  
(1 페이지, 6 번 항목 참조)

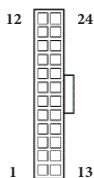

이 마더보드에는 24 핀 ATX 전원 커넥터가 탑재되어 있습니다. 20 핀 ATX 전원공급장치를 사용하려면 핀 1 과 핀 13 을 따라 연결하십시오.

ATX 12V 전원 커넥터  
(8 핀 ATX12V1)  
(1 페이지, 4 번 항목 참조)

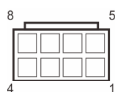

이 마더보드에는 8 핀 ATX 12V 전원 커넥터가 탑재되어 있습니다. 4 핀 ATX 전원공급장치를 사용하려면 핀 1 과 핀 5 을 따라 연결하십시오.

적외선 모듈 헤더  
(5 핀 IR1)  
(1 페이지, 22 번 항목 참조)

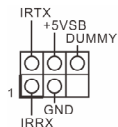

이 헤더는 선택 품목인 무선 송수신 적외선 모듈을 지원합니다.



TPM 헤더  
 (17 핀 TPMS1)  
 (1 페이지, 21 번 항목 참조)

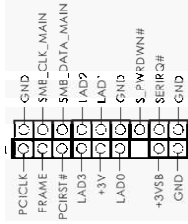

이 커넥터는 키, 디지털 인증서, 암호 및 데이터를 안전하게 보관할 수 있는 TPM(Trusted Platform Module) 시스템을 지원합니다. TPM 시스템은 네트워크 보안을 강화하고, 디지털 신원을 보호하며 플랫폼 무결성을 유지합니다.

# 1 はじめに

アスロックの一貫した厳格な品質管理の下で製造された信頼性の高いマザーボードであるアスロック P85 Pro3 マザーボードをお買い上げいただきありがとうございます。アスロックの品質と耐久性の取り組みに準拠した堅牢な設計を持つ、優れたパフォーマンスを提供します。



マザーボードの仕様と BIOS ソフトウェアは更新されることがあるため、このマニュアルの内容は予告なしに変更することがあります。このマニュアルの内容に変更があった場合には、更新されたバージョンは、予告なくアスロックのウェブサイトから入手できるようになります。このマザーボードに関する技術的なサポートが必要な場合には、ご使用のモデルについての詳細情報を、当社のウェブサイトで参照ください。アスロックのウェブサイトでは、最新の VGA カードおよび CPU サポート一覧もご覧になれます。アスロックウェブサイト <http://www.asrock.com>。

## 1.1 パッケージの内容

- アスロック P85 Pro3 マザーボード (ATX フォームファクター)
- アスロック P85 Pro3 クイックインストールガイド
- アスロック P85 Pro3 サポート CD
- 2 x シリアル ATA (SATA) データケーブル (オプション)
- 1 x I/O パネルシールド

## 1.2 仕様

- プラットフォーム**
- ATX フォームファクター
  - オール固体コンデンサー設計

- CPU**
- LGA1150 パッケージでは、第 4 世代の Intel® Core™ i7 / i5 / i3 / Xeon® / Pentium® / Celeron® をサポート
  - デジタル電源設計
  - 4 電源フェーズ設計
  - Intel® ターボブースト 2.0 テクノロジーをサポート

- チップセット**
- Intel® B85
  - Intel® スマールビジネスアドバンテージ 2.0 をサポート

- メモリ**
- デュアルチャンネル DDR3 メモリテクノロジー
  - 2 x DDR3 DIMM スロット
  - DDR3 1600/1333/1066 ECC なし、アンバッファードメモリをサポート
  - システムメモリの最大容量：16GB  
(注意を参照)
  - Intel® エクストリームメモリプロファイル (XMP) 1.3/1.2 をサポート

- 拡張スロット**
- 1 x PCI Express 3.0 x16 スロット
  - 2 x PCI Express 2.0 x1 スロット
  - 3 x PCI スロット

- 音声**
- 5.1 CH HD オーディオ (Realtek ALC662 オーディオコーデック)
  - TI® NE5532 (最大 600 Ω のプレミアムヘッドセットアンプをサポート)

- LAN**
- PCIE x1 ギガビット LAN 10/100/1000 Mb/ 秒
  - Realtek RTL8111G
  - ウェイクオンランをサポート
  - LAN ケーブル検出をサポート
  - エネルギー効率のよいイーサネット 802.3az をサポート
  - PXE をサポート

**リアパネル I/O**

- 1 x PS/2 マウスポート
- 1 x PS/2 キーボードポート
- 1 x パラレル用ポート
- 1 x シリアル用ポート
- 1 x 同軸 SPDIF 出力ポート
- 4 x USB 2.0 ポート
- 2 x USB 3.0 ポート
- LED 付き 1 x RJ-45 LAN ポート (ACT/LINK LED と SPEED LED)
- HD オーディオジャック: ラインイン / フロントスピーカー / マイク

**ストレージ**

- 4 x SATA3 6.0 Gb/ 秒コネクタ、NCQ、AHCI、「ホットプラグ」機能をサポート
- 2 x SATA2 3.0 Gb/ 秒コネクタ、NCQ、AHCI、「ホットプラグ」機能をサポート

**コネクタ**

- 1 x IR ヘッダー
- 1 x 電源 LED ヘッダー
- 1 x TPM ヘッダー
- 2 x CPU ファインコネクタ (1 x 4 ピン, 1 x 3 ピン)
- 2 x シャーシファンコネクタ (1 x 4 ピン, 1 x 3 ピン)
- 1 x 電源ファンコネクタ (3 ピン)
- 1 x 24 ピン ATX 電源コネクタ
- 1 x 8 ピン 12V 電源コネクタ
- 1 x 前面パネルオーディオコネクタ
- 1 x SPDIF Out コネクタ
- 2 x USB 2.0 ヘッダー (4 つの USB 2.0 ポートをサポート)
- 1 x USB 3.0 ヘッダー (2 つの USB 3.0 ポートをサポート)

**BIOS 機能**

- 多言語 GUI サポート付きの 64Mb AMI UEFI Legal BIOS
- ACPI 1.1 準拠のウェイクアップイベント
- SMBIOS 2.3.1 をサポート
- CPU、DRAM、PCH 1.05V 複数電圧設定

**サポート CD**

- ドライバー、ユーティリティ、アンチウイルスソフトウェア (トライアル版)、CyberLink MediaEspresso 6.5 トライアル、Google Chrome ブラウザー、ツールバー、Start8

## ハードウェアモ ニター

- CPU/ シャーシ/ 電源温度センサー
- CPU/ シャーシ/ 電源ファンタコメーター
- CPU/ シャーシ 静音ファン (CPU 温度によるシャーシファン速度の自動調整可能)
- CPU/ シャーシファンマルチ速度制御
- 電圧監視: +12V、+5V、+3.3V、CPU Vcore

## OS

- Microsoft® Windows® 8 / 8 64 ビット / 7 / 7 64 ビット準拠

## 認証

- FCC、CE、WHQL
- ErP/EuP Ready (ErP/EuP ready 電源が必要です)

\* 商品詳細については、当社ウェブサイトをご覧ください。 <http://www.asrock.com>



BIOS 設定の調整、アンタイドオーバークロックテクノロジーの適用、サードパーティのオーバークロックツールの使用などを含む、オーバークロックには、一定のリスクを伴いますのでご注意ください。オーバークロックするとシステムが不安定になったり、システムのコンポーネントやデバイスが破損することがあります。ご自分の責任で行ってください。弊社では、オーバークロックによる破損の責任は負いかねますのでご了承ください。



Windows® 32 ビットオペレーティングシステムでの、システム使用に割り当てられた実際のメモリサイズは制限のため、4GB 未満のことがあります。Windows® 64 ビットのオペレーティングシステムでは、そのような制限はありません。Windows® では使えないメモリを使用するために、アスロック XFast RAM を使用することができます。

### 1.3 ジャンパー設定

このイラストは、ジャンパーの設定方法を示しています。ジャンパーキャップがピンに被さっていると、ジャンパーは「ショート」です。ジャンパーキャップがピンに被さっていない場合には、ジャンパーは「オープン」です。この図は3ピンのジャンパーを表し、ジャンパーキャップがピン1とピン2に被さっているとき、これらのピンは「ショート」です。

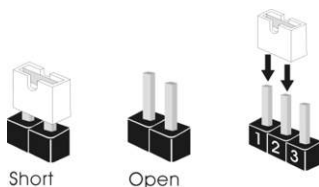

CMOS クリアジャンパー  
(CLRCMOS1)  
(p.1, No. 25 参照)



CLRCMOS1は、CMOSのデータをクリアすることができます。クリアして、デフォルト設定にシステムパラメーターをリセットするには、コンピューターの電源を切り、電源から電源コードを抜いてください。15秒待ってから、CLRCMOS1のピン2とピン3をジャンパーキャップを使って5秒間ショートします。ただし、BIOSをアップデートした直後に、CMOSをクリアしないでください。BIOSをアップデート後、CMOSをクリアする必要がある場合は、最初にシステムを起動し、それからCMOSクリアアクションを行う前にシャットダウンしてください。パスワード、日付、時間、ユーザーのデフォルトプロファイルは、CMOSの電池を取り外した場合にのみ、消去されることにご注意ください。

## 1.4 オンボードのヘッダーとコネクタ



オンボードヘッダーとコネクタはジャンパーではありません。これらヘッダーとコネクタにはジャンパーキャップを被せないでください。ヘッダーおよびコネクタにジャンパーキャップを被せると、マザーボードに永久損傷が起ることがあります。

システムパネルヘッダー  
(9ピンパネル1)  
(p.1、No. 16 参照)

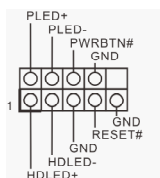

電源スイッチを接続し、スイッチをリセットし、下記のピン割り当てに従って、シャーシのシステムステータス表示ランプをこのヘッダーにセットします。ケーブルを接続するときには、ピンの+と-に気をつけてください。



### PWRBTN (電源スイッチ) :

シャーシ前面パネルの電源スイッチに接続してください。電源スイッチを使用して、システムをオフにする方法を設定できます。

### RESET (リセットスイッチ) :

シャーシ前面パネルのリセットスイッチに接続してください。コンピューターがフリーズしたり、通常の再起動を実行できない場合には、リセットスイッチを押して、コンピューターを再起動します。

### PLED (システム電源 LED) :

シャーシ前面パネルの電源ステータス表示ランプに接続してください。システム稼働中は、LED が点灯します。システムが S1/S3 スリープ状態の場合には、LED は点滅を続けます。システムが S4 スリープ状態または電源オフ (S5) のときには、LED はオフです。

### HDLED (ハードドライブアクティビティ LED) :

シャーシ前面パネルのハードドライブアクティビティ LED に接続してください。ハードドライブのデータを読み取りまたは書き込み中に、LED はオンになります。

前面パネルデザインは、シャーシによって異なることがあります。前面パネルモジュールは、主に電源スイッチ、リセットスイッチ、電源 LED、ハードドライブアクティビティ LED、スピーカーなどから構成されます。シャーシの前面パネルモジュールとこのヘッダーを接続する場合には、配線の割り当てと、ピンの割り当てが正しく合致していることを確かめてください。

電源 LED ヘッダー  
(3 ピン PLED1)  
(p.1、No. 14 参照)



システムの電源ステータスを表示するために、シャーシ電源 LED をこのヘッダーに接続してください。

シリアル ATA2 コネクタ—  
(SATA2\_4:  
p.1、No. 13 参照)  
(SATA2\_5:  
p.1、No. 12 参照)



これら 2 つの SATA2 コネクタは、最高 3.0 Gb/秒のデータ転送速度で内部ストレージデバイス用の SATA データケーブルをサポートします。

シリアル ATA3 コネクタ—  
(SATA3\_0:  
p.1、No. 9 参照)  
(SATA3\_1:  
p.1、No. 10 参照)  
(SATA3\_2:  
p.1、No. 8 参照)  
(SATA3\_3:  
p.1、No. 11 参照)

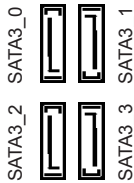

これら 4 つの SATA3 コネクタは、最高 6.0 Gb/秒のデータ転送速度で内部ストレージデバイス用の SATA データケーブルをサポートします。

USB 2.0 ヘッダー  
(9 ピン USB4\_5)  
(p.1、No. 20 参照)  
(9 ピン USB6\_7)  
(p.1、No. 19 参照)

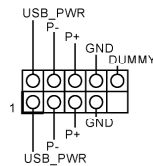

I/O パネルの 4 つの USB 2.0 ポートに加えて、このマザーボードには 2 つのヘッダーがあります。各 USB 2.0 ヘッダーは、2 つのポートをサポートできます。

USB 3.0 ヘッダー  
(19 ピン USB3\_2\_3)  
(p.1、No. 7 参照)

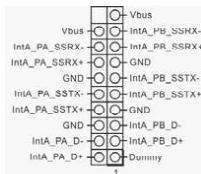

I/O パネルの 2 つの USB 3.0 ポートに加えて、このマザーボードには 1 つのヘッダーがあります。各 USB 3.0 ヘッダーは、2 つのポートをサポートできます。



## フロントパネルオーディオヘッダー

(9ピン HD\_AUDIO1)  
(p.1、No. 23 参照)

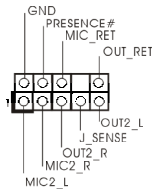

このヘッダーは、フロントオーディオパネルにオーディオデバイスを接続するためのものです。



1. ハイディフィニションオーディオはジャックセンシングをサポートしていますが、正しく機能するためには、シャーシのパネルワイヤーがHDAをサポートしている必要があります。お使いのシステムを取り付けるには、当社のマニュアルおよびシャーシのマニュアルの指示に従ってください。
2. AC'97 オーディオパネルを使用する場合には、次のステップで、前面パネルオーディオヘッダーに取り付けてください。
  - A. Mic\_IN (MIC) を MIC2\_L に接続。
  - B. Audio\_R (RIN) を OUT2\_R に、Audio\_L (LIN) を OUT2\_L に接続。
  - C. アース (GND) をアース (GND) に接続。
  - D. MIC\_RET と OUT\_RET は、HD オーディオパネル専用です。AC'97 オーディオパネルではこれらを接続する必要はありません。
  - E. フロントマイクを有効にするには、Realtek コントロールパネルの「FrontMic」タブで、「録音音量」を調整してください。

## シャーシスピーカーヘッダー

(4ピン SPEAKER1)  
(p.1、No. 15 参照)

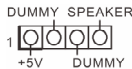

シャーシスピーカーはこのヘッダーに接続してください。

## SPDIF Out コネクタ

(2ピン SPDIF\_OUT1)  
(p.1、No. 24 参照)



ケーブルを使用して、HDMI VGA カードの SPDIF\_OUT コネクタをこのヘッダーに接続してください。

## シャーシと電源ファンコネクタ

(4ピン CHA\_FAN1)  
(p.1、No. 18 参照)

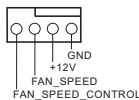

ファンケーブルはファンコネクタに接続し、黒線とアースピンを合わせてください。

(4ピン CHA\_FAN2)  
(p.1、No. 17 参照)



(3ピン PWR\_FAN1)  
(p.1、No.2 参照)

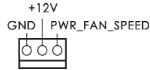

CPU ファンコネクター  
(4ピン CPU\_FAN1)  
(p.1、No.3 参照)

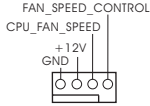

(3ピン CPU\_FAN2)  
(p.1、No.1 参照)



このマザーボードは4ピンCPUファン(静音ファン)コネクターを提供します。3ピンのCPUファンを接続する場合には、ピン1-3に接続してください。

ATX 電源コネクター  
(24ピン ATXPWR1)  
(p.1、No.6 参照)

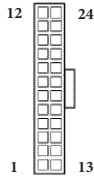

このマザーボードは24ピンATX電源コネクターを提供します。20ピンのATX電源を使用するには、ピン1と13番に合わせて接続してください。

ATX12V 電源コネクター  
(8ピン ATX12V1)  
(p.1、No.4 参照)

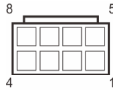

このマザーボードは8ピンATX12V電源コネクターを提供します。4ピンのATX電源を使用するには、ピン1と5番に合わせて接続してください。

赤外モジュールヘッダー  
(5ピン IR1)  
(p.1、No.22 参照)

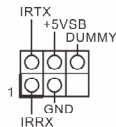

このヘッダーはオプションのワイヤレス送受信赤外モジュールをサポートしています。

TPM ヘッダー  
 (17ピン TPMS1)  
 (p.1、No. 21 参照)

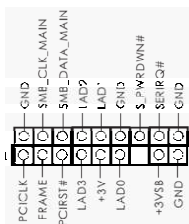

このコネクタはトラス  
 テッドプラットフォームモ  
 ジュール (TPM) システ  
 ムをサポートし、鍵、デジ  
 タル証明書、パスワード、  
 データを安全に保管する  
 ことができます。TPMシ  
 ステムはまた、ネットワ  
 ークセキュリティを高め、デ  
 ジタル証明書を保護し、  
 プラットフォームの完全  
 性を保証します。

# 1 简介

感谢您购买 ASRock P85 Pro3 主板，这是按照 ASRock 一贯严格质量控制标准生产的性能可靠的主板。它提供符合 ASRock 质量和耐久性承诺的精良设计和卓越性能。



由于主板规格和 BIOS 软件可能已更新，因此，本文档的内容可能会随时更改，恕不另行通知。如果本文档有任何修改，则更新的版本将发布在 ASRock 网站上，我们不会另外进行通知。如果您需要与此主板相关的技术支持，请访问我们的网站以具体了解所用型号的信息。您也可以在 ASRock 网站上找到最新 VGA 卡和 CPU 支持列表。ASRock 网站 <http://www.asrock.com>。

## 1.1 包装清单

- ASRock P85 Pro3 主板 (ATX 规格尺寸)
- ASRock P85 Pro3 快速安装指南
- ASRock P85 Pro3 支持光盘
- 2 x 串行 ATA (SATA) 数据线 (选购)
- 1 x I/O 面板

## 1.2 规格

### 平台

- ATX 规格尺寸
- 全固态电容器设计

### CPU

- 支持 LGA1150 封装第 4 代 Intel® Core™ i7 / i5 / i3 / Xeon® / Pentium® / Celeron®
- Digi Power (帝捷) 设计
- 4 电源相设计
- 支持 Intel® Turbo Boost 2.0 技术

### 芯片集

- Intel® B85
- 支持 Intel® Small Business Advantage 2.0

### 内存

- 双通道 DDR3 内存技术
- 2 x DDR3 DIMM 槽
- 支持 DDR3 1600/1333/1066 非 ECC, 非缓冲内存
- 支持系统内存容量: 16GB (见“注意”)
- 支持 Intel® Extreme Memory Profile (XMP)1.3/1.2

### 扩充槽

- 1 x PCI Express 3.0 x16 槽
- 2 x PCI Express 2.0 x1 槽
- 3 x PCI 槽

### 音频

- 5.1 CH 高清音频 (Realtek ALC662 音频编解码器)
- TI® NE5532 (支持最高 600 Ohms 高品质耳机放大器)

### LAN

- PCIE x1 Gigabit LAN 10/100/1000 Mb/s
- Realtek RTL8111G
- 支持 Wake-On-LAN (网上唤醒)
- 支持网路綫侦测功能
- 支持高能效以太网 802.3az
- 支持 PXE

## 后面板 I/O

- 1 x PS/2 鼠标端口
- 1 x PS/2 键盘端口
- 1 x 串行端口 : COM1
- 1 x 并行端口 (支持 ECP/EPP)
- 1 x 同轴 SPDIF 输出端口
- 4 x USB 2.0 端口
- 2 x USB 3.0 端口
- 1 x RJ-45 LAN 端口, 带 LED (ACT/LINK LED 和 SPEED LED)
- 高清音频插孔 : 线路输入 / 前扬声器 / 麦克风

## 存储

- 4 x SATA3 6.0 Gb/s 接口, 支持 NCQ、AHCI 和“热插拔”功能
- 2 x SATA2 3.0 Gb/s 接口, 支持 NCQ、AHCI 和“热插拔”功能

## 接口

- 1 x IR 接脚
- 1 x 电源 LED 接脚
- 1 x TPM 接脚
- 2 x CPU 风扇接口 (1 x 4 针, 1 x 3 针)
- 2 x 机箱风扇接口 (1 x 4 针, 1 x 3 针)
- 1 x 电源风扇接口 (3 针)
- 1 x 24 针 ATX 电源接口
- 1 x 8 针 12V 电源接口
- 1 x 前面板音频接口
- 1 x SPDIF 输出接口
- 2 x USB 2.0 接脚 (支持 4 个 USB 2.0 端口)
- 1 x USB 3.0 接脚 (支持 2 个 USB 3.0 端口)

## BIOS 功能特点

- 64Mb AMI UEFI Legal BIOS, 具有多语言 GUI 支持
- ACPI 1.1 兼容唤醒事件
- SMBIOS 2.3.1 支持
- CPU、DRAM、PCH 1.05V 电压多次调整 (Voltage Multi-adjustment)

## 支持光盘

- 驱动程序、实用程序、防病毒软件 (试用版)、CyberLink MediaEspresso 6.5 试用版、Google Chrome 浏览器和工具栏、Start8

## 硬件监控

- CPU/ 机箱 / 电源温度感测
- CPU/ 机箱 / 电源风扇转速计
- CPU/ 机箱静音风扇 (可以按照 CPU 温度自动调整机箱风扇速度)
- CPU/ 机箱风扇多种速度控制
- 电压监控: +12V、+5V、+3.3V、CPU Vcore

## 操作系统

- Microsoft® Windows® 8 / 8 64-bit / 7 / 7 64-bit 兼容

## 认证

- FCC、CE、WHQL
- ErP/EuP 支持 (需要支持 ErP/EuP 的电源)

\* 有关详细产品信息, 请访问我们的网站: <http://www.asrock.com>



须认识到超频会有一定风险, 包括调整 BIOS 设置, 应用“自由超频技术”, 或使用第三方超频工具。超频可能会影响到系统的稳定性, 甚至对系统的组件和设备造成损坏。执行这项工作您应自担风险和自己承担费用。我们对由于超频而造成的损坏概不负责。



由于限制原因, 实际内存容量可能会小于 4GB, 以保留给 Windows® 32-bit 操作系统下的系统使用。Windows® 64-bit 操作系统没有此类限制。您可以使用 ASRock XFast RAM 来利用 Windows® 不能使用的内存。

### 1.3 跳线设置

此图显示如何设置跳线。将跳线帽装到这些针脚上时，跳线“短接”。如果这些针脚上没有装跳线帽，跳线“开路”。此图显示 3 针跳线，当跳线帽装在针脚 1 和针脚 2“上，它们短接”。

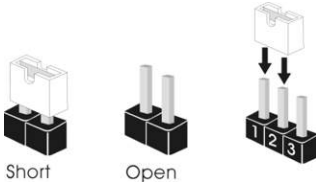

清除 CMOS 跳线  
(CLRCMOS1)

(见第 1 页, 第 25 个)



默认



清除 CMOS

CLRCMOS1 允许您清除 CMOS 中的数据。要清除和重置系统参数到默认设置，请关闭计算机，从电源上拔下电源线插头。等候 15 秒后，使用跳线帽将 CLRCMOS1 上的针脚 2 和针脚 3 短接 5 秒。但是，请勿在更新 BIOS 后立即清除 CMOS。如果您需要在刚完成 BIOS 更新后清除 CMOS，则必须先启动系统，并在关闭后再执行清除 CMOS 操作。请注意，密码、日期、时间和用户默认配置文件只在卸下 CMOS 电池后才会被清除。



## 1.4 板载接脚和接口



板载接脚和接口不是跳线。不要将跳线帽装到这些接脚和接口上。将跳线帽装到这些接脚和接口上将会对主板造成永久性损坏。

系统面板接脚  
(9 针 PANEL1)  
(见第 1 页, 第 16 个)

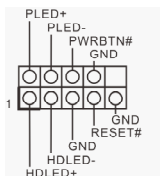

按照下面的针脚分配, 将机箱上的电源开关、重置开关和系统状态指示灯连接到此接脚。在连接线缆前请记下正负针脚。



**PWRBTN** (电源开关):

连接到机箱前面板上的电源开关。您可以配置使用电源开关关闭系统的方式。

**RESET** (重置开关):

连接到机箱前面板上的重置开关。如果计算机死机, 无法执行正常重新启动, 按重置开关重新启动计算机。

**PLED** (系统电源 LED):

连接到机箱前面板上的状态指示灯。系统操作操作时, 此 LED 亮起。系统处在 S1/S3 睡眠状态时, 此 LED 闪烁。系统处在 S4 睡眠状态或关机 (S5) 时, 此 LED 熄灭。

**HDLED** (硬盘活动指示灯):

连接到机箱前面板上的硬盘活动 LED 指示灯。硬盘正在读取或写入数据时, 此 LED 亮起。

前面板设计根据机箱不同而有所差异。前面板模块主要包括电源开关、重置开关、电源 LED、硬盘活动 LED 指示灯、扬声器等。将机箱前面板模块连接到此接脚时, 确保连线分配和针脚分配正确匹配。

### 电源 LED 接口

(3 针 PLED1)

(见第 1 页, 第 14 个)



请将机箱电源 LED 连接到此接口以指示系统电源状态。

### 串行 ATA2 接口

(SATA2\_4:

见第 1 页, 第 13 个)

(SATA2\_5:

见第 1 页, 第 12 个)



这两个 SATA2 接口支持最高 3.0 Gb/s 数据传输速率的内部存储设备的 SATA 数据线。

### 串行 ATA3 接口

(SATA3\_0:

见第 1 页, 第 9 个)

(SATA3\_1:

见第 1 页, 第 10 个)

(SATA3\_2:

见第 1 页, 第 8 个)

(SATA3\_3:

见第 1 页, 第 11 个)

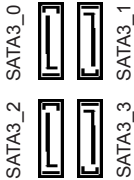

这四个 SATA3 接口支持最高 6.0 Gb/s 数据传输速率的内部存储设备的 SATA 数据线。

### USB 2.0 接口

(9 针 USB4\_5)

(见第 1 页, 第 20 个)

(9 针 USB6\_7)

(见第 1 页, 第 19 个)

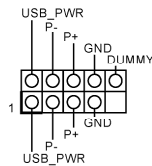

除 I/O 面板上的四个 USB 2.0 端口外, 此主板上还有两个接口。每个 USB 2.0 接口可以支持两个端口。

### USB 3.0 接口

(19 针 USB3\_2\_3)

(见第 1 页, 第 7 个)

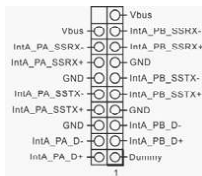

除 I/O 面板上的两个 USB 3.0 端口外, 此主板上还有一个接口。每个 USB 3.0 接口可以支持两个端口。

## 前面板音频接口

(9 针 HD\_AUDIO1)

(见第 1 页, 第 23 个)

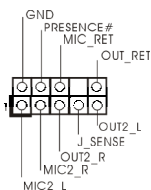

此接口用于将音频设备连接到前面板。



1. 高清音频支持插孔感测, 但机箱上的面板连线必须支持 HDA 才能正常工作。请按照我们的手册和机箱手册的说明安装系统。
2. 如果您使用 AC' 97 音频面板, 请按照以下步骤安装到前面板音频接口:
  - A. 将 Mic\_IN (MIC) 连接到 MIC2\_L。
  - B. 将 Audio\_R (RIN) 连接到 OUT2\_R, 将 Audio\_L (LIN) 连接到 OUT2\_L。
  - C. 将接地端 (GND) 连接到接地端 (GND)。
  - D. MIC\_RET 和 OUT\_RET 只用于高清音频面板。您不需要针对 AC' 97 音频面板连接它们。
  - E. 要启用前麦克风, 请转到 Realtek 控制面板上的“FrontMic” (前麦克风) 选项卡, 调整“Recording Volume” (录音音量)。

## 机箱扬声器接口

(4 针 SPEAKER1)

(见第 1 页, 第 15 个)



请将机箱扬声器连接到此接口。

## SPDIF 输出接口

(2 针 SPDIF\_OUT1)

(见第 1 页, 第 24 个)



请使用线缆将 HDMI VGA 卡的 SPDIF\_OUT 接口连接到此接口。

## 机箱和电源风扇接口

(4 针 CHA\_FAN1)

(见第 1 页, 第 18 个)

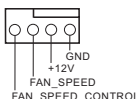

请将风扇线连接到风扇接口并使黑线匹配接地线脚。

(4 针 CHA\_FAN2)

(见第 1 页, 第 17 个)



(3 针 PWR\_FAN1)  
(见第 1 页, 第 2 个)

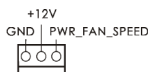

CPU 风扇接口  
(4 针 CPU\_FAN1)  
(见第 1 页, 第 3 个)

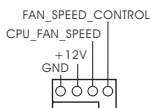

此主板提供 4 针 CPU 风扇 (静音风扇) 接口。如果您打算连接 3 针 CPU 风扇, 请将它连接到脚 1-3。

(3 针 CPU\_FAN2)  
(见第 1 页, 第 1 个)



ATX 电源接口  
(24 针 ATXPWR1)  
(见第 1 页, 第 6 个)

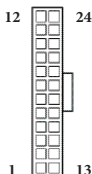

此主板提供 24 针 ATX 电源接口。要使用 20 针 ATX 电源, 请沿针脚 1 和针脚 13 插接它。

ATX 12V 电源接口  
(8 针 ATX12V1)  
(见第 1 页, 第 4 个)

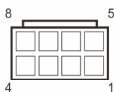

此主板提供 8 针 ATX 12V 电源接口。要使用 4 针 ATX 电源, 请沿针脚 1 和针脚 5 插接它。

红外线模块接口  
(5 针 IR1)  
(见第 1 页, 第 22 个)

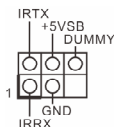

此接口支持选购的无线发射和接收红外线模块。

TPM 接口  
(17 针 TPMS1)  
(见第 1 页, 第 21 个)

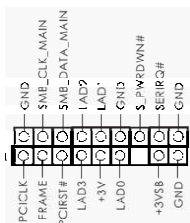

此接口支持 Trusted Platform Module (信任平台模块, TPM) 系统, 可以安全地存储密钥、数字证书、密码和数据。TPM 系统也可以帮助增强网络安全, 保护数字身份和确保平台完整性。

## 電子信息產品污染控制標示

依据中国发布的「电子信息产品污染控制管理办法」及 SJ/T 11364-2006「电子信息产品污染控制标示要求」，电子信息产品应进行标示，藉以向消费者揭露产品中含有的有毒有害物质或元素不致发生外泄或突变从而对环境造成污染或对人身、财产造成严重损害的期限。依上述规定，您可于本产品之印刷电路板上看见图一之标示。图一中之数字为产品之环保使用期限。由此可知此主板之环保使用期限为 10 年。



图一

## 有毒有害物質或元素的名稱及含量說明

若您欲了解此产品的有毒有害物质或元素的名称及含量说明，请参照以下表格及说明。

部件名称	有害物质或元素					
	铅 (Pb)	镉 (Cd)	汞 (Hg)	六价铬 (Cr (VI))	多溴联苯 (PBB)	多溴二苯醚 (PBDE)
印刷电路板及电子组件	X	O	O	O	O	O
外部信号连接器及线材	X	O	O	O	O	O

O: 表示该有毒有害物质在该部件所有均质材料中的含量均在 SJ/T 11363-2006 标准规定的限量要求以下。

X: 表示该有毒有害物质至少在该部件的某一均质材料中的含量超出 SJ/T 11363-2006 标准规定的限量要求，然该部件仍符合欧盟指令 2002/95/EC 的规范。

备注：此产品所标示之环保使用年限，系指在一般正常使用状况下。

# 1 簡介

感謝您購買 ASRock P85 Pro3 主機板，本主機板經 ASRock 嚴格品管製作，是一套讓人信賴的可靠產品。本產品採耐用設計所展現的優異效能，完全符合 ASRock 對品質及耐用度的承諾。



由於主機板規格及 BIOS 軟體可能會更新，所以本文件內容如有變更，恕不另行通知。如本文件有任何修改，可至 ASRock 網站逕行取得更新版本，不另外通知。若您需要與本主機板相關的技術支援，請上我們的網站瞭解有關您使用機型的特定資訊。您也可以到 ASRock 網站找到最新的 VGA 卡及 CPU 支援清單。ASRock 網站 <http://www.asrock.com>。

## 1.1 包裝內容

- ASRock P85 Pro3 主機板 (ATX 尺寸)
- ASRock P85 Pro3 快速安裝指南
- ASRock P85 Pro3 支援光碟
- 2 x Serial ATA (SATA) 資料纜線 (選用)
- 1 x I/O 面板外罩

## 1.2 規格

### 平台

- ATX 尺寸
- 全固態電容設計

### CPU

- 支援第 4 代 Intel® Core™ i7 / i5 / i3 / Xeon® / Pentium® / Celeron® (LGA1150 封裝)
- 數位電源設計
- 4 電源相位設計
- 支援 Intel® Turbo Boost 2.0 技術

### 晶片組

- Intel® B85
- 支援 Intel® Small Business Advantage 2.0

### 記憶體

- 雙通道 DDR3 記憶體技術
- 2 x DDR3 DIMM 插槽
- 支援 DDR3 1600/1333/1066 非 ECC、無緩衝記憶體
- 最大系統記憶體容量：16GB  
(請參閱「注意」)
- 支援 Intel® Extreme Memory Profile (XMP)1.3/1.2

### 擴充插槽

- 1 x PCI Express 3.0 x16 插槽
- 2 x PCI Express 2.0 x1 插槽
- 3 x PCI 插槽

### 音訊

- 5.1 CH HD 音訊 (Realtek ALC662 音訊轉碼器) 功能
- TI® NE5532 (支援最高 600 Ohms 的 Premium Headset Amplifier)

### LAN

- PCIe x1 Gigabit LAN 10/100/1000 Mb/s
- Realtek RTL8111G
- 支援網路喚醒
- 支援網路線偵測功能
- 支援 Energy Efficient Ethernet 802.3az
- 支援 PXE

## 後面板 I/O

- 1 x PS/2 滑鼠連接埠
- 1 x PS/2 鍵盤連接埠
- 1 x 串列埠
- 1 x 並列埠
- 1 x 同軸 SPDIF 輸出埠
- 4 x USB 2.0 連接埠
- 2 x USB 3.0 連接埠
- 1 x RJ-45 LAN 連接埠，含 LED (ACT/LINK LED 及 SPEED LED)
- HD 音訊插孔：線路輸入／前置喇叭／麥克風

## 儲存裝置

- 4 x SATA3 6.0 Gb/s 接頭，支援 NCQ、AHCI 及「熱插拔」功能
- 2 x SATA2 3.0 Gb/s 接頭，支援 NCQ、AHCI 及「熱插拔」功能

## 接頭

- 1 x IR 標頭
- 1 x 電源 LED 標頭
- 1 x TPM 標頭
- 2 x CPU 風扇接頭 (1 x 4-pin、1 x 3-pin)
- 2 x 機殼風扇接頭 (1 x 4-pin、1 x 3-pin)
- 1 x 電源風扇接頭 (3-pin)
- 1 x 24 pin ATX 電源接頭
- 1 x 8 pin 12V 電源接頭
- 1 x 前面板音訊接頭
- 1 x SPDIF 輸出接頭
- 2 x USB 2.0 標頭 (支援 4 USB 2.0 連接埠)
- 1 x USB 3.0 標頭 (支援 2 USB 3.0 連接埠)

## BIOS 功能

- 64Mb AMI UEFI Legal BIOS 含 多語 GUI 支援
- ACPI 1.1 符合喚醒自動開機
- 支援 SMBIOS 2.3.1
- CPU、DRAM、PCH 1.05V 電壓多重調整

## 支援 CD

- 驅動程式、公用程式、防毒軟體 (試用版)、CyberLink MediaEspresso 6.5 Trial、Google Chrome 瀏覽器及工具列、Start8



## 硬體監視器

- CPU / 機殼 / 電源溫度感應
- CPU / 機殼 / 電源風扇轉速計
- CPU / 機殼靜音風扇 (允許按照 CPU 溫度自動調整機殼風扇速度)
- CPU / 機殼風扇多重速度控制
- 電壓監控: +12V、+5V、+3.3V、CPU Vcore

## 作業系統

- 相容 Microsoft® Windows® 8 / 8 64 位元 / 7 / 7 64 位元

## 認證

- FCC、CE、WHQL
- ErP/EuP Ready (需具備 ErP/EuP ready 電源供應器)

\* 如需產品詳細資訊, 請上我們的網站: <http://www.asrock.com>



請務必理解, 超頻可能產生某種程度的風險, 其中包括調整 BIOS 中的設定、採用自由超頻技術或使用協力廠商的超頻工具。超頻可能會影響您系統的穩定性, 或者甚至會對您系統的元件及裝置造成傷害。您應自行負擔超頻風險及成本。我們對於因超頻所造成的可能損害概不負責。



在 Windows® 32 位元作業系統下, 因有保留供系統使用記憶體的限制, 所以實際記憶體大小可能低於 4GB。Windows® 64 位元作業系統則沒有此類限制。您可使用 ASRock XFast RAM 運用 Windows® 無法使用的記憶體。

### 1.3 跳線設定

圖例顯示設定跳線的方式。跳線蓋套在針腳上時，該跳線為「短路」。若沒有跳線蓋套在針腳上，該跳線為「開啟」。圖例顯示 3-pin 跳線的跳線蓋套在 pin1 及 pin2 時，這兩個針腳皆為「短路」。

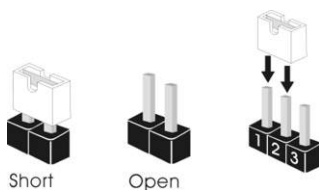

清除 CMOS 跳線  
(CLRCMOS1)  
(請參閱第 1 頁，編號 25)



預設



清除 CMOS

您可利用 CLRCMOS1 清除 CMOS 中的資料。若要清除及重設系統參數為預設設定，請先關閉電腦電源，再拔下電源供應器的電源線。在等待 15 秒後，請使用跳線蓋讓 CLRCMOS1 上的 pin2 及 pin3 短路約 5 秒。不過，請不要在更新 BIOS 後立即清除 CMOS。若您需在更新 BIOS 後立即清除 CMOS，則必須先重新啟動系統，然後於進行清除 CMOS 動作前關機。請注意，只有在取出 CMOS 電池時才會清除密碼、日期、時間及使用者預設設定檔。

## 1.4 板載標頭及接頭



板載標頭及接頭都不是跳線，請勿將跳線蓋套在這些標頭及接頭上。將跳線蓋套在標頭及接頭上，將造成主機板永久性的受損。

### 系統面板標頭

(9-pin PANEL1)

(請參閱第 1 頁，編號 16)

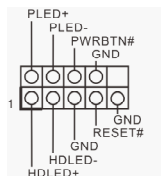

請依照以下的針腳排列將機殼上的電源開關、重設開關及系統狀態指示燈連接至此標頭。在連接纜線之前，請注意正負針腳。



#### **PWRBTN (電源開關) :**

連接至機殼前面板上的電源開關。您可設定使用電源開關閉系統電源的方式。

#### **RESET (重設開關) :**

連接至機殼前面板上的重設開關。若電腦凍結且無法執行正常重新啟動，按下重設開關即可重新啟動電腦。

#### **PLED (系統電源 LED) :**

連接至機殼前面板上的電源狀態指示燈。系統正在運作時，此 LED 會亮起。系統進入 S1/S3 睡眠狀態時，LED 會持續閃爍。系統進入 S4 睡眠狀態或關機 (S5) 時，LED 會熄滅。

#### **HDLED (硬碟活動 LED) :**

連接至機殼前面板上的硬碟活動 LED。硬碟正在讀取或寫入資料時，LED 會亮起。

各機殼的前面板設計各有不同。前面板模組主要是由電源開關、重設開關、電源 LED、硬碟活動 LED、喇叭及其他裝置組成。將機殼前面板模組連接至此標頭時，請確定佈線及針腳指派皆正確相符。

### 電源 LED 標頭

(3-pin PLED1)

(請參閱第 1 頁, 編號 14)



請將機殼電源 LED 連接至此標頭, 以指示系統的電源狀態。

### Serial ATA2 接頭

(SATA2\_4:

請參閱第 1 頁, 編號 13)

(SATA2\_5:

請參閱第 1 頁, 編號 12)



這兩組 SATA2 接頭皆支援內部儲存裝置的 SATA 資料纜線, 最高可達 3.0 Gb/s 資料傳輸率。

### Serial ATA3 接頭

(SATA3\_0:

請參閱第 1 頁, 編號 9)

(SATA3\_1:

請參閱第 1 頁, 編號 10)

(SATA3\_2:

請參閱第 1 頁, 編號 8)

(SATA3\_3:

請參閱第 1 頁, 編號 11)

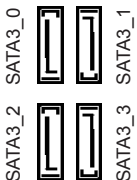

這四組 SATA3 接頭皆支援內部儲存裝置的 SATA 資料纜線, 最高可達 6.0 Gb/s 資料傳輸率。

### USB 2.0 標頭

(9-pin USB4\_5)

(請參閱第 1 頁, 編號 20)

(9-pin USB6\_7)

(請參閱第 1 頁, 編號 19)

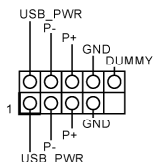

除了 I/O 面板上的四個 USB 2.0 連接埠外, 在本主機板上還有另外兩組標頭。各 USB 2.0 標頭皆可支援兩個連接埠。

### USB 3.0 標頭

(19-pin USB3\_2\_3)

(請參閱第 1 頁, 編號 7)

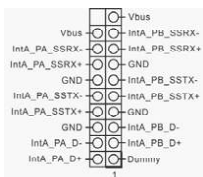

除了 I/O 面板上的兩個 USB 3.0 連接埠外, 在本主機板上還有另外一組標頭。各 USB 3.0 標頭皆可支援兩個連接埠。

## 前面板音訊標頭

(9-pin HD\_AUDIO1)

(請參閱第 1 頁, 編號 23)

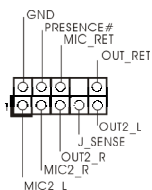

本標頭適用於連接音訊裝置至前面板音訊。



1. 高解析度音訊支援智慧型音效介面偵測 (Jack Sensing), 但機殼上的面板線必須支援 HDA 才能正確運作。請依本手冊及機殼手冊說明安裝系統。
2. 若您使用 AC' 97 音訊面板, 請按照以下步驟安裝至前面板音訊標頭:
  - A. 將 Mic\_IN (MIC) 連接至 MIC2\_L。
  - B. 將 Audio\_R (RIN) 連接至 OUT2\_R 且將 Audio\_L (LIN) 連接至 OUT2\_L。
  - C. 將接地 (GND) 連接至接地 (GND)。
  - D. MIC\_RET 及 OUT\_RET 僅供 HD 音訊面板使用。您不需要在 AC' 97 音訊面板上連接。
  - E. 若要啟動前側麥克風, 請前往 Realtek 控制面板中的「FrontMic」標籤調整「錄音音量」。

## 機殼喇叭標頭

(4-pin SPEAKER1)

(請參閱第 1 頁, 編號 15)



請將機殼喇叭連接至此標頭。

## SPDIF 輸出接頭

(2-pin SPDIF\_OUT1)

(請參閱第 1 頁, 編號 24)



請使用纜線將 HDMI VGA 卡的 SPDIF\_OUT 接頭接至此標頭。

## 機殼及電源風扇接頭

(4-pin CHA\_FAN1)

(請參閱第 1 頁, 編號 18)

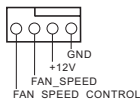

請將風扇纜線連接至風扇接頭, 並比對黑線及接地針腳。

(4-pin CHA\_FAN2)

(請參閱第 1 頁, 編號 17)



(3-pin PWR\_FAN1)  
(請參閱第 1 頁, 編號 2)

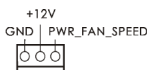

CPU 風扇接頭  
(4-pin CPU\_FAN1)  
(請參閱第 1 頁, 編號 3)

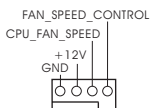

(3-pin CPU\_FAN2)  
(請參閱第 1 頁, 編號 1)



本主機板配備 4-Pin CPU 風扇(靜音風扇)接頭。若您計畫連接 3-Pin CPU 風扇, 請接至 Pin 1-3。

ATX 電源接頭  
(24-pin ATXPWR1)  
(請參閱第 1 頁, 編號 6)

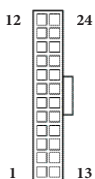

本主機板配備一組 24-pin ATX 電源接頭。若要使用 20-pin ATX 電源供應器, 請插入 Pin 1 及 Pin 13。

ATX 12V 電源接頭  
(8-pin ATX12V1)  
(請參閱第 1 頁, 編號 4)



本主機板配備一組 8-pin ATX 12V 電源接頭。若要使用 4-pin ATX 電源供應器, 請插入 Pin 1 及 Pin 5。

紅外線模組標頭  
(5-pin IR1)  
(請參閱第 1 頁, 編號 22)

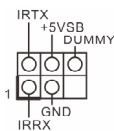

此標頭支援選用的無線傳送及接收紅外線模組。

TPM 標頭  
(17-pin TPM1)  
(請參閱第 1 頁, 編號 21)

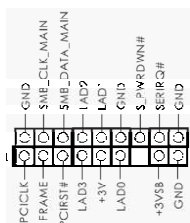

此接頭支援信賴平台模組 (TPM) 系統, 可確保儲存金鑰、數位憑證、密碼及資料的安全。TPM 系統也能強化網路安全、保護數位身分並確定平台完整性。

# 1 Pendahuluan

Terima kasih telah membeli motherboard ASRock P85 Pro3, yakni motherboard andal yang diproduksi di bawah kendali mutu ketat yang sejalan dengan ASRock. Motherboard ini memberikan performa luar biasa dengan desain canggih yang meneguhkan komitmen ASRock terhadap kualitas dan ketahanan.



*Karena spesifikasi motherboard dan perangkat lunak BIOS dapat di-update, maka isi dokumentasi ini akan berubah sewaktu-waktu tanpa pemberitahuan sebelumnya. Jika terdapat perubahan pada dokumentasi ini, maka versi baru akan tersedia di situs web ASRock tanpa pemberitahuan lebih lanjut. Jika Anda memerlukan dukungan teknis terkait motherboard ini, kunjungi situs web kami untuk mendapatkan informasi khusus tentang model yang Anda gunakan. Anda juga dapat menemukan kartu VGA dan daftar dukungan CPU terkini di situs web ASRock. Situs web ASRock <http://www.asrock.com>.*

## 1.1 Isi Kemasan

- Motherboard ASRock P85 Pro3 (Bentuk dan Ukuran ATX)
- Panduan Ringkas ASRock P85 Pro3
- CD Dukungan ASRock P85 Pro3
- 2 x Kabel Data SATA (Serial ATA) (Opsional)
- 1 x Pelindung Panel I/O

## 1.2 Spesifikasi

- Platform**
- Bentuk dan Ukuran ATX
  - Desain Kapasitor Solid

- CPU**
- Mendukung Intel® Core™ i7 / i5 / i3 Generasi Ke-4 / Xeon® / Pentium® / Celeron® dalam Paket LGA1150
  - Desain Digi Power
  - Desain 4 Fase Daya
  - Mendukung Teknologi Intel® Turbo Boost 2.0

- Chipset**
- Intel® B85
  - Mendukung Intel® Small Business Advantage 2.0

- Memori**
- Teknologi Memori DDR3 Kanal Ganda
  - 2 x Slot DDR3 DIMM
  - Mendukung DDR3 1600/1333/1066 non-ECC, memori tanpa buffer
  - Kapasitas maksimum memori sistem: 16GB (lihat PERHATIAN)
  - Mendukung Intel® Extreme Memory Profile (XMP)1.3/1.2

- Slot Ekspansi**
- 1 x Slot PCI Express 3.0 x16
  - 2 x Slot PCI Express 2.0 x1
  - 3 x Slot PCI

- Audio**
- Audio HD 5.1 CH (Realtek ALC662 Audio Codec)
  - TI® NE5532 (mendukung Premium Headset Amplifier hingga 600 Ohms)

- LAN**
- PCIE x1 Gigabit LAN 10/100/1000 Mb/s
  - Realtek RTL8111G
  - Mendukung Wake-On-LAN
  - Mendukung Deteksi Kabel LAN
  - Mendukung Energy Efficient Ethernet 802.3az
  - Mendukung PXE



### Panel I/O Belakang

- 1 x Port Mouse PS/2
- 1 x Port Keyboard PS/2
- 1 x Serial port: COM1
- 1 x Parallel port
- 1 x Port Keluaran Coaxial SPDIF
- 4 x Port USB 2.0
- 2 x Port USB 3.0
- 1 x Port LAN RJ-45 dengan LED (ACT/LINK LED dan SPEED LED)
- Soket Audio HD: Saluran masuk/Speaker Depan/Mikrofon

### Penyimpanan

- 4 x Konektor SATA3 6,0 Gb/s, mendukung fungsi NCQ, AHCI, dan "Hot Plug"
- 2 x Konektor SATA2 3,0 Gb/s, mendukung fungsi NCQ, AHCI, dan "Hot Plug"

### Konektor

- 1 x Header IR
- 1 x Kepala LED daya
- 1 x Header TPM
- 2 x Konektor kipas CPU (1 x 4-pin, 1 x 3-pin)
- 2 x Konektor kipas chassis (1 x 4-pin, 1 x 3-pin)
- 1 x Konektor kipas daya (3-pin)
- 1 x Konektor daya ATX 24 pin
- 1 x Konektor daya 12V 8 pin
- 1 x Konektor audio panel depan
- 1 x Konektor SPDIF Out
- 2 x Header USB 2.0 (mendukung 4 port USB 2.0)
- 1 x Header USB 3.0 (mendukung 2 port USB 3.0)

### Fitur BIOS

- 64Mb AMI UEFI Legal BIOS dengan dukungan GUI Multibahasa
- ACPI 1.1 Kompatibel dengan Aktivitas Pengaktifan
- Dukungan SMBIOS 2.3.1
- Multipengatur Tegangan CPU, DRAM, PCH 1,05V

### Dukungan CD

- Driver, Utilitas, Perangkat Lunak AntiVirus (Versi Uji Coba), CyberLink MediaEspresso 6.5 Uji Coba, Google Chrome Browser dan Toolbar, Start8

- Perangkat Keras Monitor**
- Sensor Suhu CPU/Chassis/Kipas
  - Takometer CPU/Chassis/Kipas Daya
  - Kipas Hening CPU/Chassis (Memungkinkan Penyesuaian Otomatis Kecepatan Kipas Chassis Berdasarkan Suhu CPU)
  - Kontrol Multikecepatan Kipas CPU/Chassis
  - Pemantauan Tegangan: +12V, +5V, +3,3V, CPU Vcore
- OS**
- Kompatibel dengan Microsoft® Windows® 8 / 8 64-bit / 7 / 7 64-bit
- Sertifikasi**
- FCC, CE, WHQL
  - Siap untuk ErP/EuP (memerlukan catu daya untuk ErP/EuP)

\* Untuk informasi tentang produk rinci, kunjungi situs web kami: <http://www.asrock.com>



Perlu diketahui, overclocking memiliki risiko tertentu, termasuk menyesuaikan pengaturan pada BIOS, menerapkan Teknologi Untied Overclocking, atau menggunakan alat overclocking pihak ketiga. Overclocking dapat mempengaruhi stabilitas sistem, atau bahkan dapat mengakibatkan kerusakan komponen dan perangkat sistem. Risiko dan biaya apapun menjadi tanggungan Anda. Kami tidak bertanggung jawab atas kemungkinan kerusakan karena overclocking.



Karena keterbatasan, ukuran memori sebenarnya mungkin kurang dari 4GB karena akan digunakan sistem berdasarkan sistem operasi Windows® 32-bit. Sistem operasi Windows® 64-bit tidak memiliki keterbatasan tersebut. Anda dapat menggunakan ASRock XFast RAM untuk memanfaatkan memori yang tidak dapat digunakan Windows® tersebut.

## 1.3 Konfigurasi Jumper

Gambar menunjukkan cara mengkonfigurasi jumper. Bila penutup jumper diletakkan pada pin, maka jumper akan “Pendek”. Jika tidak ada penutup jumper yang diletakkan pada pin, maka jumper akan “Terbuka”. Gambar menunjukkan jumper 3-pin, yakni pin1 dan pin2 menjadi “Pendek” bila penutup jumper diletakkan pada 2 pin tersebut.

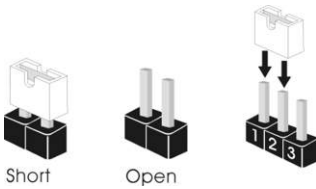

Clear CMOS Jumper  
(CLRCMOS1)  
(lihat hal. 1, No. 25)



Default

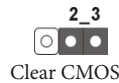

Clear CMOS

CLRCMOS1 memungkinkan Anda mengosongkan data di CMOS. Untuk mengosongkan dan mengatur ulang parameter sistem ke konfigurasi default, matikan komputer, lalu lepas kabel daya dari catu daya. Setelah menunggu selama 15 detik, gunakan penutup jumper untuk memendekkan pin2 dan pin3 pada CLRCMOS1 selama 5 detik. Namun, jangan kosongkan CMOS tepat setelah Anda meng-update BIOS. Jika Anda harus mengosongkan CMOS setelah selesai meng-update BIOS, boot up dulu sistem, lalu matikan sebelum melakukan tindakan clear-CMOS. Perhatikan bahwa sandi, tanggal, waktu, dan profil default pengguna akan dikosongkan hanya jika baterai CMOS dikeluarkan.

## 1.4 Header dan Konektor Onboard



Header dan konektor terpasang **BUKANLAH** jumper. **JANGAN** letakkan penutup jumper pada header dan konektor tersebut. Meletakkan penutup jumper pada header dan konektor akan mengakibatkan kerusakan permanen pada motherboard.

Header Panel Sistem  
(PANEL1 9-pin)  
(lihat hal. 1, No. 16)

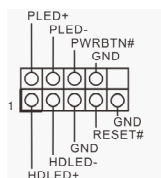

Sambungkan switch daya, atur ulang indikator status sistem dan switch daya pada chassis ke header tersebut berdasarkan penetapan pin di bawah ini. Perhatikan pin positif dan negatif sebelum menyambungkan kabel.



**PWRBTN (Switch Daya):**

Sambungkan ke switch daya pada panel depan chassis. Anda dapat mengkonfigurasi cara mematikan sistem menggunakan switch daya.

**RESET (Switch Atur Ulang):**

Sambungkan switch atur ulang pada panel depan chassis. Tekan switch atur ulang untuk mengatur ulang komputer jika komputer tidak merespons dan gagal melakukan pengaktifan ulang normal.

**PLED (LED Daya Sistem):**

Sambungkan ke indikator status daya pada panel depan chassis. LED akan menyala bila sistem sedang beroperasi. LED akan terus berkedip bila sistem dalam kondisi tidur S1/S3. LED akan mati bila sistem dalam kondisi tidur S4 atau mati (S5).

**HDLED (LED Aktivitas Hard Drive):**

Sambungkan ke LED aktivitas hard drive pada panel depan chassis. LED akan menyala bila hard drive sedang membaca atau menulis data.

Desain panel depan dapat berbeda menurut chassis. Modul panel depan biasanya terdiri atas switch daya, switch atur ulang, LED daya, LED aktivitas hard drive, speaker, dll. Bila menyambungkan modul panel depan chassis ke header, pastikan penetapan kabel dan pin disesuaikan dengan benar.

Header LED Daya  
(PLED1 3-pin)  
(lihat hal. 1, No. 14)



Sambungkan LED daya chassis ke header ini untuk menunjukkan status daya sistem.

Konektor Serial ATA2  
(SATA2\_4:  
lihat hal. 1, No. 13)  
(SATA2\_5:  
lihat hal. 1, No. 12)



Kedua konektor SATA2 ini mendukung kabel data SATA untuk perangkat penyimpanan internal dengan kecepatan transfer data hingga 3,0 Gb/s.

Konektor Serial ATA3  
(SATA3\_0:  
lihat hal. 1, No. 9)  
(SATA3\_1:  
lihat hal. 1, No. 10)  
(SATA3\_2:  
lihat hal. 1, No. 8)  
(SATA3\_3:  
lihat hal. 1, No. 11)

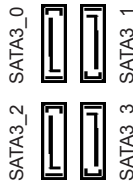

Keempat konektor SATA3 ini mendukung kabel data SATA untuk perangkat penyimpanan internal dengan kecepatan transfer data hingga 6,0 Gb/s.

Header USB 2.0  
(USB4\_5 9-pin)  
(lihat hal. 1, No. 20)  
(USB6\_7 9-pin)  
(lihat hal. 1, No. 19)

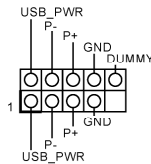

Selain empat port USB 2.0 pada panel I/O, terdapat dua header pada motherboard ini. Masing-masing header USB 2.0 dapat mendukung dua port.

Header USB 3.0  
(USB3\_2\_3 19-pin)  
(lihat hal. 1, No. 7)

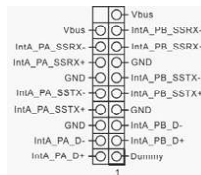

Selain dua port USB 3.0 pada panel I/O, terdapat satu header pada motherboard ini. Masing-masing header USB 3.0 dapat mendukung dua port.

Header Audio Panel  
Depan  
(HD\_AUDIO1 9-pin)  
(lihat hal. 1, No. 23)

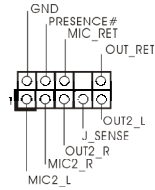

Header ini untuk menyambungkan perangkat audio ke panel audio depan.



1. Audio Definisi Tinggi mendukung Sensor Soket, namun kabel panel pada chassis harus mendukung HDA agar berfungsi dengan benar. Ikuti petunjuk dalam panduan pengguna ini dan panduan pengguna chassis untuk menginstal sistem.
2. Jika Anda menggunakan panel audio AC'97, pasang ke header audio panel depan dengan melakukan langkah-langkah di bawah ini:
  - A. Sambungkan Mic\_IN (MIC) ke MIC2\_L.
  - B. Sambungkan Audio\_R (RIN) ke OUT2\_R dan Audio\_L (LIN) ke OUT2\_L.
  - C. Sambungkan Ground (GND) ke Ground (GND).
  - D. MIC\_RET dan OUT\_RET hanya untuk panel audio HD. Anda tidak perlu menyambungkannya untuk panel audio AC'97.
  - E. Untuk mengaktifkan mikrofon depan, buka tab "FrontMic" pada Panel kontrol Realtek, lalu sesuaikan "Volume Perekaman".

Header Speaker Chassis  
(SPEAKER1 4-pin)  
(lihat hal. 1, No. 15)

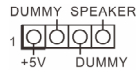

Sambungkan speaker chassis ke header ini.

Konektor SPDIF Out  
(SPDIF\_OUT1 2-pin)  
(lihat hal. 1, No. 24)



Sambungkan konektor SPDIF\_OUT kartu VGA HDMI ke header ini menggunakan kabel.

Konektor Kipas Chassis dan Daya  
(CHA\_FAN1 4-pin)  
(lihat hal. 1, No. 18)

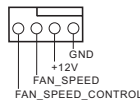

Sambungkan kabel kipas ke konektor kipas, lalu cocokkan kabel hitam dengan pin ground.

(CHA\_FAN2 4-pin)  
(lihat hal. 1, No. 17)



(PWR\_FAN1 3-pin)  
(lihat hal. 1, No. 2)

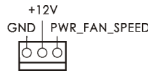

Konektor Kipas CPU  
(CPU\_FAN1 4-pin)  
(lihat hal. 1, No. 3)

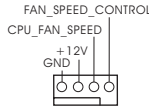

(CPU\_FAN2 3-pin)  
(lihat hal. 1, No. 1)



Motherboard ini memberikan konektor kipas CPU 4-Pin (Kipas Hening). Jika Anda berencana untuk menyambungkan kipas CPU 3-Pin, sambungkan ke Pin 1-3.

Konektor Daya ATX  
(ATXPWR1 24-pin)  
(lihat hal. 1, No. 6)

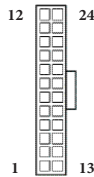

Motherboard ini memberikan konektor daya ATX 24-pin. Untuk menggunakan catu daya ATX 20-pin, pasang bersama Pin 1 dan Pin 13.

Konektor Daya ATX 12V  
(ATX12V1 8-pin)  
(lihat hal. 1, No. 4)

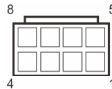

Motherboard ini memberikan konektor daya ATX 12V 8-pin. Untuk menggunakan catu daya ATX 4-pin, pasang bersama Pin 1 dan Pin 5.

Header Modul  
Inframerah  
(IR1 5-pin)  
(lihat hal. 1, No. 22)

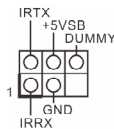

Header ini mendukung modul transmisi nirkabel opsional dan menerima modul inframerah.

Header TPM  
(TPMS1 17-pin)  
(lihat hal. 1, No. 21)

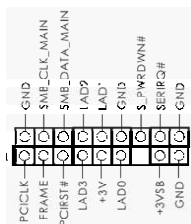

Konektor ini mendukung sistem TPM (Trusted Platform Module), yang dapat menyimpan kode kunci, sertifikat digital, sandi, dan data secara aman. Sistem TPM juga membantu meningkatkan keamanan jaringan, melindungi identitas digital, dan memastikan integritas platform.



## Contact Information

If you need to contact ASRock or want to know more about ASRock, you're welcome to visit ASRock's website at <http://www.asrock.com>; or you may contact your dealer for further information. For technical questions, please submit a support request form at <http://www.asrock.com/support/tsd.asp>

### **ASRock Incorporation**

2F., No.37, Sec. 2, Jhongyang S. Rd., Beitou District,

Taipei City 112, Taiwan (R.O.C.)

### **ASRock EUROPE B.V.**

Bijsterhuizen 3151

6604 LV Wijchen

The Netherlands

Phone: +31-24-345-44-33

Fax: +31-24-345-44-38

### **ASRock America, Inc.**

13848 Magnolia Ave, Chino, CA91710

U.S.A.

Phone: +1-909-590-8308

Fax: +1-909-590-1026